

AD-A258 685



2

Contract No. DAMD17-88C-8058

Army Medical Imaging System - ARMIS

Melvin P. Siedband  
Frank C. Grenzow  
Craig A. Heilman  
James R. Gray  
Huilian Zhang

SA  
ELECTRONICS  
DEC 03 1992

425-560

92-30696



92 12 02 040

Contract No. DAMD17-88C-8058

## Army Medical Imaging System - ARMIS

Melvin P. Siedband  
Frank C. Grenzow  
Craig A. Heilman  
James R. Gray  
Huilian Zhang

University of Wisconsin  
Department of Medical Physics  
1300 University Avenue  
Madison, Wisconsin 53706

August 8, 1992

Final Report

Prepared For:  
U.S. Army Medical Research and Development Command  
Fort Detrick  
Frederick, Maryland 21702-5012

Approved for public release; distribution unlimited.  
The findings in this report are not to be construed as an official  
Department of the Army position unless so designated  
by other authorized documents.

Accession For	
NTIS CPA&I	<input checked="" type="checkbox"/>
DTIC TAB	<input type="checkbox"/>
Unannounced	<input type="checkbox"/>
Justification	
By	
Distribution/	
Availability Codes	
Dist	Availability or Special
A-1	

# REPORT DOCUMENTATION PAGE

Form Approved  
OMB No. 0704-0188

Public reporting burden for this collection of information is estimated to average 1 hour per response, including the time for reviewing instructions, searching existing data sources, gathering and maintaining the data needed, and completing and reviewing the collection of information. Send comments regarding this burden estimate or any other aspect of this collection of information, including suggestions for reducing this burden, to Washington Headquarters Services, Directorate for Information Operations and Reports, 1215 Jefferson Davis Highway, Suite 1204, Arlington, VA 22202-4302, and to the Office of Management and Budget, Paperwork Reduction Project (0704-0188), Washington, DC 20503.

1. AGENCY USE ONLY (Leave blank)	2. REPORT DATE 8 Aug 92	3. REPORT TYPE AND DATES COVERED Final 21 Dec 87 - 31 Mar 92
----------------------------------	----------------------------	---

4. TITLE AND SUBTITLE Army Medical Imaging System - ARMIS	5. FUNDING NUMBERS Contract # DAMD17-88C-8058 63807A 3M463807D836 HE 041 DA314043
--	--

6. AUTHOR(S) Melvin P. Siedband                      James R. Gray Frank C. Grenzow                         Huilian Zhang Craig A. Heilman	
---	--

7. PERFORMING ORGANIZATION NAME(S) AND ADDRESS(ES) University of Wisconsin Department of Medical Physics 1300 University Avenue Madison, WI 53706	8. PERFORMING ORGANIZATION REPORT NUMBER
---	--

9. SPONSORING/MONITORING AGENCY NAME(S) AND ADDRESS(ES) U.S. Army Medical Research and Development Command Fort Detrick Frederick, Maryland 21702-5012	10. SPONSORING/MONITORING AGENCY REPORT NUMBER
--	--

11. SUPPLEMENTARY NOTES

12a. DISTRIBUTION/AVAILABILITY STATEMENT  Approved for public release; distribution unlimited.	12b. DISTRIBUTION CODE
---	------------------------

13. ABSTRACT (Maximum 200 words)

The Army Medical Imaging System (ARMIS) would use optical data cards, discs and small computers to perform the required functions of image acquisition, archiving, duplicating, reporting and scheduling. A study done under a previous contract, DAMD17-86-C-6039, determined the optimal configuration of a filmless medical imaging system based on stimuable x-ray phosphors and optical data cards. Advantages of the system would be elimination of film, development chemicals, and the need for water; reduction of power requirements, bulk media, archive volume and cost per image. Items to be delivered are demonstration models of a stimuable phosphor screen laser scanner, an image acquisition workstation, and an optical digital data card based independent viewer. Subcontractor bids for the stimuable phosphor scanner were far higher than original estimates solicited from potential bidders prior to the award of this contract. As a result, the scope of this contract was limited to the development of an imaging workstation based on the Apple Macintosh™, an independent viewer to display the contents of optical data cards and software techniques for image data compression and transmission.

14. SUBJECT TERMS X-Ray, Filmless Radiography, Digital Radiography, Radiography, RA 2	15. NUMBER OF PAGES 71
	16. PRICE CODE

17. SECURITY CLASSIFICATION OF REPORT Unclassified	18. SECURITY CLASSIFICATION OF THIS PAGE Unclassified	19. SECURITY CLASSIFICATION OF ABSTRACT Unclassified	20. LIMITATION OF ABSTRACT Unlimited
---	--	---	---

## Table of Contents

I. Introduction. . . . .	1
II. Purpose. . . . .	3
III. General Description. . . . .	4
IV. X-Ray Cassette Scanner. . . . .	6
A. Operation of the System. . . . .	6
B. Stimulable Phosphors. . . . .	7
C. Cassette Scanner. . . . .	8
1. Memory Requirements. . . . .	9
2. Processing Requirements. . . . .	9
V. Optical Digital Data Cards. . . . .	11
VI. Monitors. . . . .	15
A. Display Resolution. . . . .	15
B. Monitor Orientation. . . . .	16
C. Refresh Rate. . . . .	17
D. Bits Per Pixel. . . . .	18
E. CRT Phosphors. . . . .	18
VII. Radiographic Workstation. . . . .	19
A. Operation of the System. . . . .	19
B. Base Computer. . . . .	19
C. Video Display. . . . .	20
D. Small Computer Systems Interface (SCSI). . . . .	21
E. Hard Disk Storage. . . . .	22
F. Optical Archive. . . . .	23
G. DIN/PACS. . . . .	25
1. ACR/NEMA Standard. . . . .	26
2. Ethernet. . . . .	27
3. ISDN. . . . .	28
H. Software. . . . .	29
1. Development Environment. . . . .	29
2. Control Program. . . . .	30
a) Main Control Shell. . . . .	30
(1) Apple Menu. . . . .	32
(2) File Menu . . . . .	33
(3) Edit Menu. . . . .	36
(4) Annotate Menu. . . . .	37

(5) Algorithm Menu. . . . .	40
(6) Image Menu. . . . .	41
(7) Preferences Menu. . . . .	42
b) Image Display Program. . . . .	43
c) Patient Report Form Program. . . . .	44
d) Optical Card Reader/Writer SCSI Device Driver. . . . .	46
3. Data Compression. . . . .	46
a) Block Truncation Coding. . . . .	47
b) Filtered Block Truncation Coding. . . . .	49
VIII. Independent Viewer. . . . .	52
A. Operation of the System. . . . .	52
B. Development System. . . . .	55
C. Base Computer. . . . .	57
D. Floating-Point Accelerator Board. . . . .	58
1. Accelerator Board Specifications. . . . .	60
2. Computing Speed Advantage. . . . .	61
E. Software. . . . .	62
1. Development Environment. . . . .	62
2. Control Program. . . . .	63
3. Data Expansion. . . . .	64
F. Expansion Bus Conflicts. . . . .	65
IX. Potential For Improvement. . . . .	66
X. Conclusions. . . . .	69

## I. Introduction

The contract between the University of Wisconsin and the U.S. Army Medical Research and Development Command, DAMD17-88C-8058, was for the development of a complete filmless x-ray system. Items to be delivered were demonstration models of a stimuable phosphor screen laser scanner, a digital radiographic image acquisition workstation, an optical digital data card (DDC) based independent viewer, and a final report describing the results of the project.

Funds were to be made available for the subcontracting of the stimuable phosphor scanner and x-ray cassettes with stimuable phosphor screens. Bids were far higher than original estimates solicited from potential bidders prior to the award of this contract. As a result, the scope of this contract was limited to the development of an imaging workstation based on the Apple Macintosh™, an independent viewer to display the contents of optical data cards and software techniques for image data compression and transmission suitable for optical data card and data disc storage. The system can accept images from sources other than the cassette scanner. Various optical scanners were used to obtain images from x-ray films and other image sources to demonstrate the feasibility of optical data cards as a practical medium for the storage and distribution of medical images.

A study was done under a previous contract, No. DAMD17-86-C-6039, to determine an optimal configuration of a filmless medical imaging system based on stimuable x-ray phosphors and optical data cards. The stimuable phosphors can be exposed to x-rays and will store the latent image until read by a laser beam. The image is digitized when scanned by the laser beam, stored as digital information in the random access memory (RAM) of a small computer and displayed on the monitor. Optical digital data cards (DDC's) use the same data storage principle as audio compact discs. The computer can store and retrieve image data using the DDC as a write-once/read-many (WORM) device. The credit card size DDC's can store 8 compressed images and several pages of text. Practical advantages of the DDC scheme are: a volume reduction of supplies of more than 100 times, no need for film or development chemicals, data immunity to severe environments (especially low level radiation), tolerance of long-term storage, and low cost.

The general ideas of the filmless system are that each major device has its own image RAM and that communication between the devices will be via the small computer systems

interface, SCSI. Communication between complete systems, e.g. teleradiology, would be via the DIN/PACS interface. Other medical imaging sources such as CT, MRI, and ultrasound machines could be connected to the system via the DIN/PACS interface. A complete assembly with such interfaces would comprise the basic Army Medical Imaging System, ARMIS. Major components of the ARMIS filmless x-ray system would include a cassette scanner with several x-ray cassettes, a radiographic workstation, a DDC reader/writer, an independent viewer, a DIN/PACS interface, and a data link interface. Because SCSI-compatible optical disc devices are being developed for many small computers, it was thought that they would be useful as local image/report archive devices. However, they were not included as part of the research or demonstration effort but are shown in some of the system diagrams.

## II. Purpose

The ARMIS is a filmless system intended to perform many of the medical imaging functions of a conventional small clinic or field hospital. It would use optical data cards, discs and small computers to perform the required functions of image acquisition, archiving, duplicating, reporting and scheduling. Instead of x-ray film cassettes, stimuable phosphor cassettes would be used. The film archive would be replaced by a local disc or wired to a larger image archive. Duplicate films and reports would be replaced by selected images and the report duplicated on the optical data cards. In place of illuminated view boxes for films, a simple and inexpensive independent viewer would display the contents of the cards. The initial image display, diagnosis and preparation of the report would be done at the small computer display console. Important advantages of the system would be elimination of all film and development chemicals, elimination of the need for water, reduction of power requirements, more than a 100 times reduction of bulk media and archive volume. There would also be a considerable reduction in cost per image.



### III. General Description

A block diagram of the basic clinical imaging system is shown in Figure 1. The stimuable phosphor cassettes would be exposed in a conventional manner and with the normal radiographic techniques. The quantum detection efficiencies of stimuable phosphors are similar to those of conventional x-ray intensifier screens and patient exposures would be consistent with those of conventional radiography. After the cassettes are exposed, they are read by the scanner and displayed on the four monitors of the computer. The operator may adjust the contrast and brightness (window width and level) of each image and accept the image for storage in the computer hard disk and release the scanner to read the next cassette. Images may be recalled from the computer hard disk, interpreted, annotated and the report written for storage on the optical disc, selected and copied to an optical card, or sent to an external system. The essential components of the system are the stimuable phosphor cassettes, the cassette scanner, the computer control and display, the optical disc local archive and the optical card reader/writer.

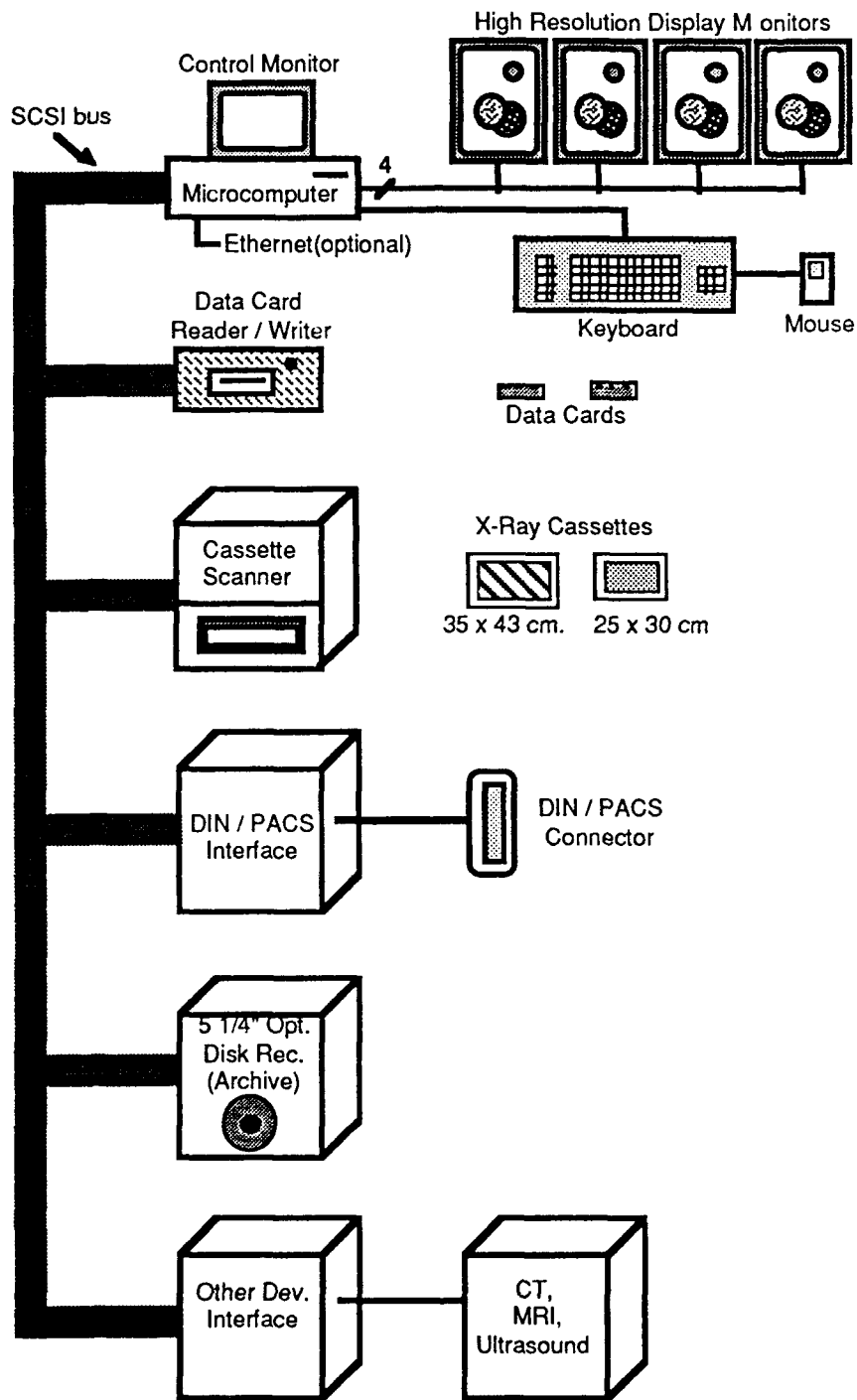

Figure 1. Basic Clinical System

## IV. X-Ray Cassette Scanner

The phosphor cassette scanner assembly was to be comprised of a small reader mechanism, five 25 x 30 cm cassettes and five 35 x 43 cm cassettes. Two complete assemblies were to be delivered. Connecting cables and detailed technical information needed for servicing were also to be provided. Since the phosphor screen cassette scanner subcontract was not released as outlined above, the following describes the initial goals and eventual purpose.

### A. Operation of the System

The design of a cassette scanner is such that a filmless cassette can be used in the same manner as a standard film cassette. An x-ray cassette incorporating a stimulable phosphor screen is used and exposed with the same factors as a conventional cassette and placed in the cassette scanner. A laser scans the screen point by point and the response is measured, digitized and stored in the scanner RAM as a 1024 x 1280 x 12 bit field. Each image thus requires 1.92 MB of RAM space. Once the scanner memory is full, the scanner prevents further loading of cassettes until some images are erased or passed to the radiographic workstation. The number of images that may be held in the scanner depends on the size of the RAM resident in the scanner. Once an image has been retrieved and verified at the radiographic workstation, the corresponding scanner memory bank is cleared. Images are retrieved by the radiographic workstation for display, annotation, diagnosis and storage. The status of each operation will be displayed on the front panel of the scanner.

When an image is to be displayed at the radiographic workstation, the computer will initiate a SCSI command to transfer the image to computer RAM as an 8-bit image and subsequently to the video display card. The operator can examine the image and decide if the default 12 -> 8 bit selection algorithm is appropriate. If the contrast or brightness is not acceptable, a different algorithm can be selected and the image retransmitted. Menu commands are used to designate the selection algorithm. A cassette can be scanned into one memory bank and an image in another memory bank can be transmitted to the radiographic workstation at the same time. The operator can annotate the image in the computer and save the image on the computer's hard disk. A patient ID block will automatically be attached to the image when it is saved on the hard disk. After an image has

been saved or discarded, a SCSI command will notify the scanner that it can erase the corresponding memory bank. The scanner may then read another cassette.

## B. Stimulable Phosphors

Stimulable phosphors are also called memory screens or storage phosphors. When exposed to x-rays, the screen fluoresces and electrons are driven into traps. When later scanned by a red laser, a second blue fluorescence occurs. A filter separates the red laser light from the blue fluorescence light. The blue fluorescence light enters the detector where an electronic signal is produced, digitized and stored.

Cassettes using storage phosphors can be exposed using the same exposure settings as conventional x-ray cassettes. In general, x-ray factors are determined by acceptable noise limits of the radiograph which, in turn, are functions of the quantum statistics of the x-ray photons and the quantum efficiency of the detector. Conventional x-ray screens are thick for high sensitivity/low resolution and thin for high resolution/low sensitivity. Obviously, the thickness of the screen determines both resolution and sensitivity. A conventional cassette uses two screens (except for mammography) as tests have shown that two thin screens exposing both surfaces of a double emulsion film are better than one thicker screen of the same total thickness exposing a single emulsion. A storage phosphor cassette uses only one screen because of the scanning process. The quantum efficiency and resolution would be similar to the two screen system as the laser light tends to scatter less than the fluorescence. If the memory screen were made thicker to improve quantum efficiency, then a problem of laser beam penetration versus scattering might occur: certain picture elements might not be sufficiently stimulated by the laser to fluoresce and there would be some image carry-over to the next image. This could be reduced by a light flooding operation after laser scanning.

Several companies have been evaluating storage phosphor systems where the scanned image is digitally processed and reproduced on single emulsion photographic film. Clinical results have been excellent and the cost/image is reduced. Exposure/image is about the same as conventional radiography but the appearance of the images and retake rates have been improved. In conventional radiography, several film sizes are used to save film costs. In this system, it is assumed that only two formats are required for radiography as electronic image processing can expand the final image. Thus, only 25 x 30 cm (10 x 12 inch) and 35 x 43 cm (14 x 17 inch) cassettes are proposed. Additional

cassette sizes may be added for spotfilming or other special needs. The scanning parameters would be almost the same, as larger formats have lower resolution as a result of large area scatter and the effects of patient thickness.

### C. Cassette Scanner

The cassette reader should permit daylight loading. Insertion of the cassette should initiate the reading action and the cassette should not be removable until read or released by an override mechanism. The dynamic range of processed images should be within a range of 8 bits. However, errors of exposure or a need to examine some region of interest in more detail suggest that initial acquisition should be at the greater depth of 12 bits. When the 12 bit image is viewed at the radiographic workstation, the operator will reduce the range to 8 bits by selection of contrast, brightness and gradient.

The configuration of the cassette reader should be such that both cassette sizes can be read. While several commercial stimuable phosphor systems scan at 2048 lines or higher, their images are copied onto single emulsion films. Such screen to film systems do not have a data storage limitation imposed by digital data storage capacity. The reduced resolution of the ARMIS system should mean a lesser requirement for precision of the scanning mechanism. If an existing commercial 2048 line scanning device is modified for this application, then either the scanning parameters must be changed or data must be accumulated by pixel averaging. Merely accepting alternate pixel data on alternate lines of a 2048 line image to produce a 1024 line image wastes information and would increase patient exposure; such methods are not acceptable.

In summary, the cassette reader should:

- 1) be self-contained and self-powered (115 VAC, 60 Hz, 1 KW max) and "look like" a SCSI device to an Apple Macintosh computer.
- 2) provide a circuit breaker power switch, manual reset switch or initialization button, functional display and/or status lights. These should indicate: power on, computer transmission, cassette scanning, memory banks empty/full, error conditions (jams, faults, etc.).
- 3) accept x-ray cassettes of sizes 25 x 30 cm and 35 x 43 cm. Cassettes with manually removable dark slides are preferred to automatic mechanisms.

- 4) read and digitize the radiological image at 1024 x 1280 x 12 bit resolution within 10 - 20 seconds.
- 5) store the image in a local image memory RAM of 1.9 MB (minimum).
- 6) provide special (P)ROM or ALU circuit to convert 12 bit image data to 8 bits (gradient selection). At least 16 preprogrammed selection algorithms should be available.
- 7) permit removal of the storage phosphor cassette after it has been read. If a special (manual by-pass) reset/release mechanism is used, then this will also erase the reading RAM. Cassette cannot be inserted in machine unless one or more of the memory banks is empty.
- 8) provide a SCSI interface for scanner control and transmission of the image to the radiographic workstation.
- 9) prevent the reading or scanning of additional radiographic images unless an empty memory bank is available.
- 10) be small, compact and rugged; about the size of a desk-top copying machine.

## 1. Memory Requirements

Several things influence the amount of memory required for the cassette scanner. The desired number of images that can be held in temporary storage until transferred to the radiographic workstation will directly affect the RAM requirements of the scanner. As stated before, each 1024 x 1280 x 12 bit image will require 1.92 MB of temporary memory. If the cassette scanner is to hold, say, 5 images before transfer, then nearly 10 MB of RAM is required just for storage. The gradient selection methods implemented in the scanner may also affect RAM requirements. Depending on how the particular processing algorithms are implemented, memory demands could be substantial. RAM costs have decreased significantly in the last few months but prices can still be quite volatile. In order to minimize costs yet provide a reasonable size image store, it is recommended that at least 5 MB (appr. 2 images + processing space) be provided in the cassette scanner.

## 2. Processing Requirements

The nature of the 12->8 bit gradient selection algorithms will determine the processing power required in the cassette scanner. Simple gradient selections such as "use bottom 8/12 bits" or "use top 8/12 bits" should not require any extra processing

hardware. If the scanner memory is bit or nibble addressable, many gradient selections are simply a matter of addressing the memory correctly. For more complex gradient selection algorithms, a dedicated processor may be required. Since the set of gradient selection algorithms can be considered immutable at the time the scanner is manufactured, a preprogrammed PAL or PROM may suffice.

## V. Optical Digital Data Cards

Optical digital data cards, DDC's, are a relatively new form of optical storage technology. Although the technology is very similar to that of CD-ROM and WORM discs, there are several important differences where size, capacity and cost are concerned. DDC's are the same size as a credit card and currently have a raw data capacity of 4.0 MB. The use of error correction results in a usable capacity of 2.9 MB. This should be sufficient to store either 2 uncompressed 1.3 MB images or 8 or more compressed images, plus several pages of text. The cost of optical data cards is low, about two dollars each. They may replace x-ray films costing more than twenty-five times as much and can result in a bulk storage reduction of more than 100 times [1].

Most optical digital data cards are now manufactured to a common standard [2]. Machines from several manufacturers will be able to read and write on the same cards. A data card is shown in Figure 2 and one example of a card reader/writer is shown in Figure 3. Optical data cards are immune to high magnetic field effects and, within a zip-locked bag, are also immune to moisture and other hostile environments. A Japanese study [3] has shown no loss or degradation of optical card data over a two month period of extreme use.

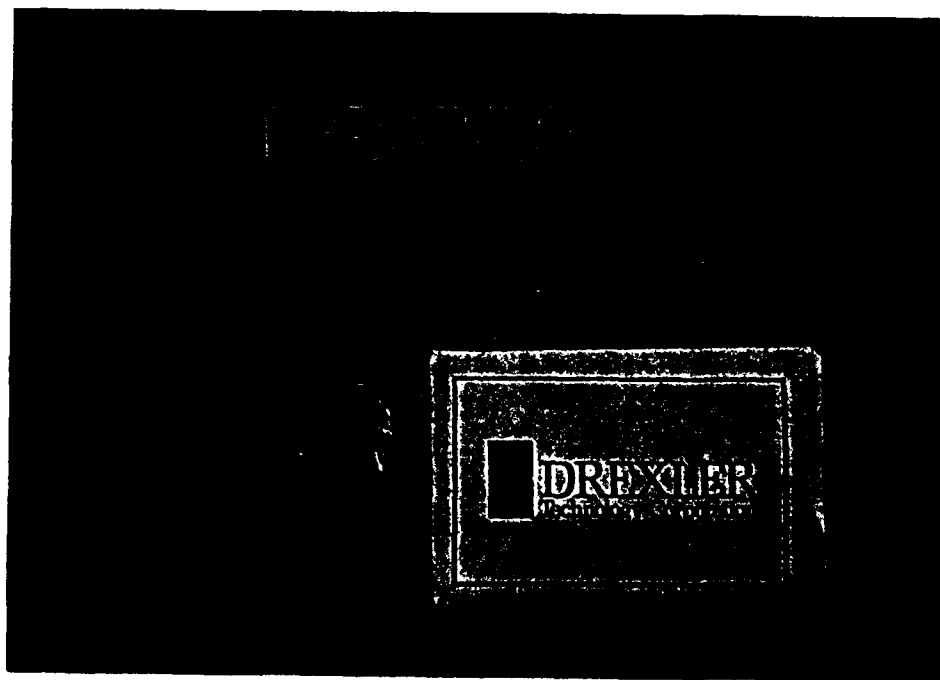

Figure 2. Optical Data Card



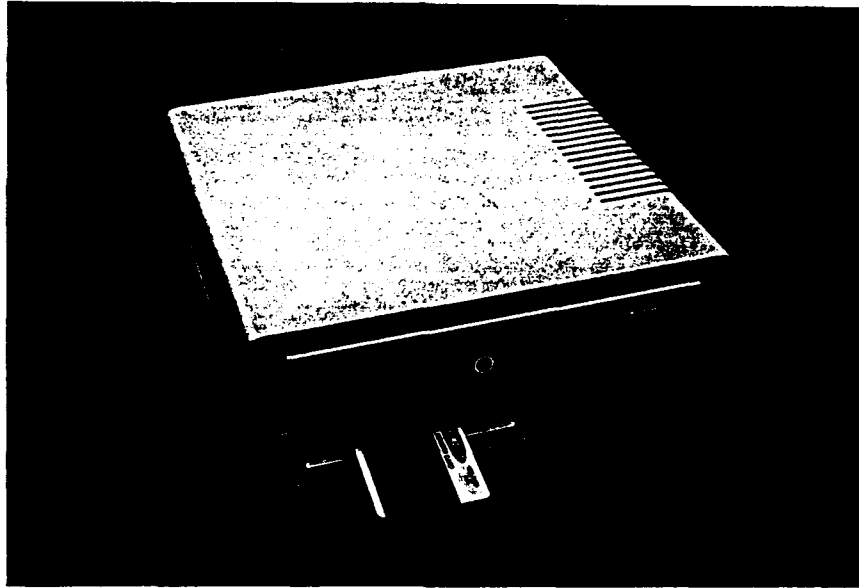

Figure 3. Optical Data Card Reader/Writer

The basic technology of reading and writing optical data cards is similar to that used for audio compact discs [4]. In order to write a data card, a laser beam is focused to less than 5 mm and erodes an internal mirror surface. Figure 4 shows the data pits on a small section of a commercial data card. About 0.25 mJ is required to burn a small pit; a 50 mW laser can write 20 k pits or bits per second. In theory, a 1.0 W laser should be capable of writing data at 400 Kbits/sec. To read a card, a low power laser scans the card and the reflected pattern of light is detected by silicon cells. The reading code requires 13 bit spaces to read one byte in order to track the data pattern and provide stop and start signals.

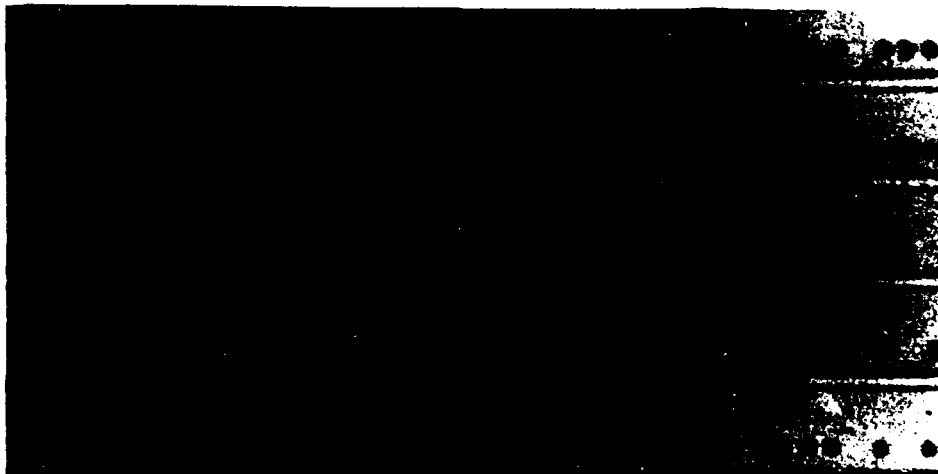

Figure 4. Optical Pit Pattern

The writing action at the reflective surface of the DDC occurs at a very high local temperature. Photographic processes are not used so that the card is immune to extremes of temperature and to low level ionizing radiation. The polycarbonate overlay is quite rugged and sufficiently thick so that the laser beam, focussed in the plane of the reflector, will not resolve fine scratches at the surface. The card can be placed in a thin vinyl envelope and accompany the soldier through various levels of combat casualty care. Cards can be mailed or filed without special care or handling. The ARMIS system can copy the contents of the DDC's to produce duplicate cards.

As audio compact discs, CD's, spin, the circular data tracks are read by two reading circuits. The digital data is encoded to limit the size of gaps in the data stream. This is necessary for the operation of the tracking circuits. Minor positional or tracking errors are compensated for as part of the reading process. The reading data rate is in excess of 120 Kbps. The DDC data is recorded in rectilinear form and requires a reciprocating motion with error compensation to read and write. A spinning motion would not require the rapid acceleration of the mechanism and the consequent increase of the positional errors. However, the x-y coordinates of the data tracks allow better control of the placement and categorizing of the data on the card. This ability to place data at random positions may be essential to perform the control and addressing functions so that information may be added as one image or one page of text at a time.

The tradeoff for using a rectilinear data format appears to be a reduction of the maximum data transfer rate. At present, raw data may be written at between 16 and 32 Kbps and read at between 64 and 128 Kbps on an Olympus card reader/writer. A Conlux reader/writer has a specified raw data read and write data rate of 80 Kbps. Several manufacturers have indicated that new machines will have twice that speed and future machines will double that rate again. With the use of 4:1 data compression, a 1024 x 1024 x 8-bit (1.0 MB) image file (262 KB compressed) currently can be written in between 300 and 360 seconds. The Olympus unit can read the same file in 120 seconds and the Conlux unit can read it in 90 seconds. These times translate into effective reading data rates of 17.44 and 23.2 Kbps respectively. The goal is 10 seconds to write and 2 seconds to read an image file.

Alternative optical data cards are also being developed by other companies. These cards incorporate a dye layer in front of the internal reflecting surface. The energy required to convert the dye layer from transparent to opaque is less than that to erode the reflecting layer. There may be questions of the resistance to radiation and aging effects of this method. One

company advocates the use of a spinning laser head assembly with arc segments on the data card.

One alternative to the optical card has been developed by the Dow Chemical Company. This card resembles a 5.0 cm diameter center section of a compact music disc and can store about 30 MB of user data. It uses a non-ablating principle of altering the reflectance of the internal storage surface. By increasing the spacing of the stored data "pits" to reduce the data capacity to, say, 10 MB, the *mechanical tolerances can be reduced which may lower the data error rate*. This small disc could be handled in the same way as the small data card and transported in a small "zip-locked" bag. The use of this small disc could make possible a further reduction of costs of the independent viewer as many of the high-production components of music and computer compact disc hardware could be adapted readily for this application. Also, helical reading mechanisms are inherently faster than the reciprocating actions required for cards. It is important to note that no production plans have been announced for the small discs.

The two reader/writer devices that were used for this project are the Olympus and the Nippon Conlux LC-303. Neither machine was used with the prototype radiographic workstation due to the lack of SCSI device drivers for the Apple Macintosh. All reader/writer testing was done on the AT-based independent viewer.

## VI. Monitors

There are only a handful of high resolution monitor manufacturers in the United States. Video Monitors Inc. (VMI) manufactures the 1024 x 1280 x 8 bits/pixel portrait monitor used in this project. VMI was chosen because they build monitors exactly to the customers requirements. Other companies sell monitors with features unnecessary for this application or require the purchase of their video board.

### A. Display Resolution

Film-screen combinations used for medical radiography are of several types. A thick, sensitive screen offers reduced exposure at a compromise of resolution while a thin screen increases the radiation exposure needed but improves the resolution. Chest radiography uses the thick sensitive screen and arteriography would use the higher resolution thin screen. As the x-ray energy increases the beam stopping power of the screen decreases, a thicker screen may be needed to have the same sensitivity as a thin screen at lower energies. Mammographic screens are thin and have the same x-ray beam stopping power at 28 kVp (generator operating voltage) as a thick chest screen at 140 kVp. The resolution of film screens can be measured by imaging a lead bar pattern or a fine lead slit and calculating the equivalent sine wave response. That spatial frequency response can be normalized by assuming that the lowest frequency amplitude is equal to 1.0 and that the response past the first zero is ignored, i.e., phase changes past the zero are not considered. The normalized spatial frequency response is called the modulation transfer function (MTF). The MTF can then be converted to an expression describing the ability to see small objects.

The expression used most often is the noise equivalent resolution or  $N_e$  and is found by integrating the generating function of the MTF. This process is necessary as some image recording schemes will have a "flat" frequency response and others will "fall-off" and not respond as smoothly. When the amplitude of the MTF is about 0.05, 5%, objects close to that size or bar patterns close to that spatial frequency tend to disappear in the background noise and this is called the disappearance frequency or limiting resolution. The  $N_e$  and the limiting resolution are not the same and it can be demonstrated that  $N_e$  is a more useful measure of clinical performance of a system.

There is a complication when comparing film-screens with digital TV displays: one has a continuous MTF and the other is quantized by the discrete pixels corresponding to data points in the display RAM. However, if the frequency response of the acquired image data is well above the display pixel density, then the pixel density is related closely to the MTF of the quantized display. A 1024 pixel display mapped into the acquired image field of 35 cm corresponds to an  $N_e$  of 1.6 lp/mm, rather close to the  $N_e$  of a film-screen used for chest imaging (close to 1.8 - 2.0 lp/mm). Because the film-screen decays to lower frequencies beyond the  $N_e$ , the film-screen image will look better than the TV display where the  $N_e$  and the limiting resolution are almost the same frequency.

In general, the displayed resolution of 1024 x 1280 pixels will be adequate, close to the performance of corresponding film-screens. If higher image resolutions are required for diagnosis, the field size can be decreased, use a smaller format with the same 1024 x 1280 pixels i.e., instead of a 35 x 43 cm image, use 25 x 30 cm and, for example, examine the right and left lung fields separately. Obviously, smaller anatomic structures should be displayed at higher resolutions.

While it is possible to construct display systems of almost any resolution, a design compromise must be made. One film company has said that acquisition resolution values of not less than 5000 x 6400 pixels and 16 bit amplitude levels must be used to avoid the threat of negligence and malpractice. That same company was marketing a teleradiology system of 512 x 512 x 6 bits! So far, the consensus is that images of 1024 x 1280 pixels will suffice for most medical imaging, 2048 x 2048 is better but costs more. Clinical testing and experience will be the only way to resolve the issue. Cost is an important factor and higher resolution and bit depth are factors in determining system cost.

## B. Monitor Orientation

The most frequent monitor format is that of the portrait mode, long axis vertical. Radiographs of the chest are almost always shown in that position. Practical considerations suggest that the scanning lines should sweep the long axis because the retrace time and settling time of that circuit are fixed for a given set of components. By scanning the long axis, the number of scanning lines is reduced, the active scan time is maximized, the bandwidth is reduced and the signal to noise ratio is also maximized. To

have the long axis vertical requires that the deflection yoke must be rotated with the kinescope and the deflection parameters are 1024 visible scanning lines, 1280 pixels/line. This is the configuration used for the independent viewer. The monitor drive boards are insensitive to the orientation of the yoke providing that pixel addresses accommodate the orientation. The eye is insensitive to the direction of the scanning lines.

The Macintosh uses an ingenious scheme for presenting the position of the cursor and adding text and symbolic annotation to the monitors. The advantage of that method means that the cursor can be moved readily from one monitor to the next in a single motion, following the movement of the mouse. This scheme assumes that the scanning lines are horizontal so that the portrait mode display for this application requires 1280 visible scanning lines and 1024 pixels/line. Thus, the two applications require different scanning characteristics. Fortunately, the same monitor can be configured for either application. A future version of the driver board could permit the Macintosh monitor configuration to work in the independent viewer.

### C. Refresh Rate

Conservation of bandwidth is important for optimum operation of camera tubes. The refresh rate of common television conserves bandwidth by the use of an interlaced scan; two half-frames or fields at the power line frequency, complete images at 1/2 the power line frequency. This results in a "flicker frequency" of 60 Hz and the image is stationary with respect to stray electromagnetic fields of the power line. As long as images are moving, the system works well. This idea of interlaced scanning is similar to what is done in motion picture projection where the image frame rate is 24 frames/sec and the projected light is shuttered once or twice more each frame to increase the flicker frequency above the frame rate. The light is shuttered during film transport time. The eye can sense annoying flicker at 24 Hz but not at the flash rate of 48 to 72 Hz of the projector. For images of stationary objects, close examination of interlaced TV image details shows a "shimmer" or satiny appearance which is distracting to the viewer. Most computer images do not use interlaced scanning and operate at frame rates near the power line frequency. Conservation of bandwidth is not necessary as the image is stored in RAM. The new developments of high definition TV, HDTV, also use RAM circuits to convert the slower camera TV images to the higher rate flickerless displays. The image refresh rate and display characteristics of the ARMIS system are the same as those being used in the higher level CAD, computer-aided design, systems and close to those

proposed for HDTV. The non-interlaced display at the high refresh rate permits close examination of stationary objects without eyestrain or distracting artifacts.

#### D. Bits Per Pixel

Users are often confused about what the eye is capable of seeing. Just as edge effects have an impact on resolution, the number of bits per pixel required to make good images has more to do with boundaries and transitions. If you ask a person to differentiate gray levels by showing isolated patches of various gray shades, eight to 10 shades would be identified at best. If the image has adjacent patches of smaller amplitude variation the number increase to at least 64 shades and, in some experiments, close to 100 shades.

An experiment can be done where various test images have amplitude quantized images and the number of gray levels of the image is varied. The experiment is further simplified when the image is quantized on a binary scale, 64, 128, 256 levels, etc. Most observers can discern the transition of levels when 64 (6 bit) levels are used. The transition in a medical image could show up as the margin between two levels in a relatively clear field, as an artifact in a lung field, as the edge of a faint tumor that really is not there. To permit some adjustment of brightness, experience has shown that 256 levels (8 bits) is adequate for displayed information. Displayed information is not the same as acquired information and elsewhere in this report, the need to acquire information at 10 to 12 bit levels is discussed.

#### E. CRT Phosphors

In order for any CRT to produce an image, an electron beam within the CRT must strike a phosphor coating on the inside face of the tube (the display screen). There are over a hundred different types of phosphors available. Normally, for medical applications a P4 or a P45 is used. Clinton, the manufacturer of the CRTs used by Video Monitors Inc. (VMI) uses a variant of the P4, the P104 phosphor. The P104 is a white-white phosphor and the P45 is a white-blue phosphor. The first color indicates the fluorescence and the second color is the phosphorescence. The P4 (104) is the most popular and is used in all the ARMIS monitors. The P45 is sometimes requested because it has a bluish tint similar to radiographic film.

## VII. Radiographic Workstation

### A. Operation of the System

After a phosphor screen cassette has been scanned by the scanner, the digital x-ray image can be retrieved by the radiographic workstation. One of several 12->8 bit gradient selection criteria can be chosen within the radiographic workstation computer program. If no selection criterion is chosen, a default criterion will be used. The desired image is then transferred to the radiographic workstation and displayed on one of four monitors. If the image is not satisfactory, a new selection criterion is chosen and the image retrieved again. Once the image is of the desired quality, it must be saved on the hard disk. Note that the image must be labeled with the required patient data before it is saved. Images that have been saved on the hard disk can later be retrieved for annotation. A diagnosis can then be entered on the report form. A report and image set can then be archived in optical storage and copied to a DDC for a referring physician if so desired. Image retrieval is accomplished using a Macintosh II from Apple Computer Inc. The Macintosh II was chosen because it has a Small Computer Systems Interface (SCSI) port and a user-friendly graphical control interface.

### B. Base Computer

The Apple Macintosh II contains a 16 MHz Motorola MC68020 CPU. A 256 KB ROM contains portions of the operating system and the "Toolbox", several hundred routines available for programming the machine. The Macintosh II can be configured with 1-8 MB of physical RAM with standard 1-Mbit DRAMs. New, higher density DRAMs (4-Mbit) and the promise of virtual memory will allow even larger amounts of system memory. The 6-slot backplane is a high speed 32-bit, 10 MHz bus based upon the NuBus standard (IEEE 1196) developed by Texas Instruments. The Apple DeskTop Bus (ADB) is used for connecting input devices such as keyboards, graphics tablets and the mouse. There are six other I/O devices: an Apple Sound Chip (ASC) for sound generation; two Synertek SY6522A Versatile Interface Adapters (VIA); a Zilog Z8530 Serial Communications Controller (SCC) providing two serial ports; an Apple custom chip, the IWM (Integrated Woz Machine) for disk control; the Motorola MC68881 numerics coprocessor; and a NCR 5380 Small Computer Systems Interface (SCSI) chip for high-speed parallel communications [5].



One major characteristic desirable in a computer workstation is expansion capability. The use of standard bus and serial port structures, such as NuBus, SCSI and RS422 (RS-232 compatible), allows the Macintosh II to easily communicate with the outside world. Many different peripherals such as laser printers, modems, scanners, hard disk drives, dot matrix printers, erasable-optical disc drives, CD-ROM drives, WORM disc drives and tape drives are fully supported by the Macintosh line of computers.

The user interacts with the Macintosh through a graphical user interface, GUI, rather than the text or line command interface used by many other computers. A GUI is fast, convenient, and grasped very easily by inexperienced users. The Macintosh GUI is uniform and consistent across hundreds of Macintosh programs. Thus, reference to the manual of a *new* application is typically unnecessary until the experienced user desires a special feature. This represents a strong advantage over UNIX and MS-DOS computer systems where the same button combinations have different interpretations in different applications. One study comparing Apple Macintosh and MS-DOS personal computer systems showed that users find Macintosh easier to learn and more enjoyable to use thus resulting in greater efficiency and productivity [6]. A computer tool is less effective when its use is inconsistent to the people who must manage it. The consistency of the Macintosh operating system permits easier staff training as imaging applications are designed. The trade off of a simple interface is the increased effort required for programming.

The Macintosh II can be upgraded to a Macintosh Iix which incorporates the more advanced Motorola MC68030 CPU. Further, it is hinted that a RISC based machine is planned. Several accelerator boards with high-speed CPU's are currently on the market. One vendor has indicated it has available, special boards based upon multiple INMOS transputer chips, which could invite performance comparisons with mini-supercomputers for special applications. While such performance is not currently necessary, radiological demands of the 1990's may require it.

### C. Video Display

A typical Macintosh II display is either the Apple 13" RGB color monitor or the 12" monochrome monitor. Both of these monitors have a display resolution of 640 x 480 pixels. The standard Apple video card comes with enough video memory to display 4-bit pixels. More memory can be added so that 8-bit pixels can be displayed. Color (on a

color monitor) or gray scale and the number of bits per pixel are both software configurable. A standard Macintosh monitor is not of sufficient resolution to display digital radiographs but is useful for text information such as patient records and reports. Third party monitors can be added to a Macintosh II system by simply adding the proper video boards. Some of the currently available video boards have resolutions as high as 1280 x 1024 x 32. Since this application uses 1024 x 1280 x 8-bit images, a board with a resolution of 1024 x 1280 x 8 is desirable.

A specially programmed Truevision HR Graphics Card is being used in conjunction with a custom high resolution monitor from Video Monitors Inc. (VMI). The HR Graphics Card comes with either 2 or 4 MB of video memory and can be programmed for numerous display resolutions (all at 8-bits per pixel). A portrait mode resolution of 1024 x 1280 is being used since it provides an aspect ratio of 0.8, which is close to the optimal ratio of 0.75 (3:4).

Since there are six NuBus slots available, as many as six monitors can be added to the Macintosh II. The recommended configuration for the radiographic workstation is one standard Apple monitor (color or monochrome) and four high resolution monitors. This configuration will allow a radiologist to compile the patient report while viewing several images.

#### D. Small Computer Systems Interface (SCSI)

The SCSI interface is a standard and is used for data transmission between external hard disk drives (or any other attached SCSI device) and the computer at 1.4 Mbps [7]. Since SCSI has a reasonable transmission speed and is included in all Macintosh computers, it is the logical choice for communications with other devices. A maximum of seven SCSI devices may be attached to a Macintosh. Chip sets which implement the SCSI interface and protocols are readily available. Many of the currently available DDC reader/writer devices already come with a SCSI interface. It is assumed that it would not be difficult to build the phosphor screen scanner with a SCSI interface.

Although SCSI devices are readily connected physically via SCSI cables, software is required for proper communication. Most SCSI devices require an operating system specific driver to handle low level device communications. Drivers must be written for each operating system that the device is to be used with. Although many of the DDC

reader/writer's come with a physical SCSI interface, all of the companies have yet to implement SCSI drivers for the Macintosh. A special utility program was used to successfully communicate with a DDC reader/writer connected to a Macintosh. With the addition of a driver it would be possible to read and write DDCs directly on the Macintosh.

#### E. Hard Disk Storage

In order to temporarily store images at the radiographic workstation, a hard disk drive is required. The system will also run much faster if the application program and the Macintosh operating system are resident on a hard drive instead of a floppy disk. Hard drives are available for the Macintosh in sizes ranging from 20 MB to 1.2 GB. A 20 MB drive would only allow the temporary storage of approximately 15 high resolution images whereas a 1.2 GB drive could hold over 900 non-compressed images. More temporary storage can be added by simply using multiple drives. As many as seven hard drives can be attached to a single Macintosh via the SCSI bus.

There are several characteristics which define a hard disk drive. The most visible are storage capacity and form factor. Storage capacity is the amount of data that a drive can hold, usually given in megabytes, MB. Form factor is the physical size of the drive media. Two standard microcomputer hard drive form factors are 5.25" and 3.5". Drives with a particular form factor also typically come in two heights, full-height and half-height. The drive height determines the number of platters, and thus the capacity, of the drive. If the drive is to be mounted inside the microcomputer, then the amount of space available often determines the form factor. A full height 5.25" drive can be mounted inside a Macintosh II only with the addition of a special bracket. Since all Macintosh computers have an external SCSI port, any size external SCSI drive can be used.

Two important, but often overlooked, characteristics of a hard drive are average access time and transfer rate or throughput. Average access time is usually defined as the sum of two other terms, seek time and latency. Seek time is the amount of time for the drive heads to move to a particular location (track) on the disk. Latency is the amount of time needed for the desired data block (sector) to rotate underneath the drive heads so reading or writing can occur. A drive with a low average access time can locate and begin reading or writing data faster than one with a high average access time. Typical access times are in the tens of milliseconds (mS). High-capacity (>300 MB) hard drives have better access times due to the use of more expensive, faster technology such as voice coil

actuators, better drive heads and denser platter surfaces. They also use a separate disk platter as a dedicated servo surface to maintain tracking information [8].

Throughput or transfer rate is defined as the amount of data that a drive can transfer in a given amount of time, usually given in bits, kilobits, or megabytes per second. Once a drive has located the desired track and sector, it must move data between the drive and the computer. A high throughput drive will take less time to transfer the data than a low throughput drive. The use of disk caching and zoned-bit recording can significantly increase a drive's data transfer rate. Note that transfer rates can be limited not only by the drive, but also by the interface bus (SCSI) and the driver software. The Macintosh Plus SCSI interface has read/write transfer rates of 263 Kbps and 2693 Kbps respectively. A fast drive will have read/write transfer rates close to the 13,107 Kbps maximum rating of the SCSI bus in a Macintosh II [8]. Again, high-capacity disk drives offer significantly higher data transfer rates than smaller drives, and will thus give much greater performance.

The current hard disk drive configuration for the prototype Macintosh-based radiographic workstation is two drives totaling 190 MB of storage. One is an external SuperMac DataFrame XP150 which is based upon a 150 MB Wren mechanism from Iprimis (formerly the hard drive division of Control Data Corp.). The Wren mechanism is well known for its reliability, speed and throughput. The XP150 has an average access time of 16.5 msec, a peak transfer rate of 1.5 Mbytes/sec and a sustainable transfer rate of 625 Kbytes/sec [9]. The other drive is an internal Apple Hard Disk 40SC which is based upon a 40 MB Quantum mechanism.

#### F. Optical Archive

There are three types of optical disc technology currently on the market: CD-ROM (compact disc read only memory), WORM (write once/read many) and erasable optical. All these technologies offer random access, high capacity, physically compact, non-volatile storage with reasonable access times and transfer rates. A disc with 650 MB of capacity can store up to 2600 compressed images with a very low cost per MB. Larger, 12" or 14", optical disks are available which can store 10 gigabytes of data. Further, the University of Wisconsin's Physical Sciences Laboratory has designed a computerized optical archival storage device that fits within a small room and stores 2 terabytes of data. This is equivalent to approximately 8 million compressed, high resolution images.

Optical storage is immune to magnetic and electrical field disturbances and can handle adverse environments. Discs can be easily handled, stored, or mailed without affecting the data. Though the discs are similar, there are significant differences between the technologies.

A CD-ROM disc is 4.75 inches in diameter, can hold 650 MB of data and is the oldest of the technologies. The High Sierra standard and the International Standards Organization standard (ISO 9660) are the two main standards presently in use [10]. Access times are relatively slow compared to the other two technologies. Discs are produced fairly inexpensively from a master source disc thus suiting their main purpose as distribution media. Since data cannot be added to a CD-ROM, this technology is not useful for archiving medical images.

WORM and erasable optical discs are 5.25 inches in diameter, come in a 5.3" x 6" cartridge, are typically double-sided and can hold between 650 MB and 1.2 GB of data. WORM is the second oldest of the three technologies and is very stable and well proven. Data is written by burning small pits in the substrate reflective layer of the disc. An "embedded servo" is used in which the disk is formatted by burning additional laser tracks to guide the read/write head. The data can then be read by a lower power laser beam which tracks the spiral of pits. This optical storage method has an estimated data lifetime of hundreds of years.

Erasable optical discs are the newest of the optical storage technologies. Most are based upon magneto-optical technology which uses both a laser and a magnetic field to write data on a disc. The media is a magnetic material in which the sequence of bits have a magnetic field of north-pole-up (digital 1) or north-pole-down (digital 0) [11]. The field required to change the magnetic domain of a bit varies greatly with temperature. At room temperature the coercive force is so high that the domain remains unaffected by typical magnetic fields. If a 1 micrometer spot on the disc is heated to 150° C for a few nanoseconds, a bias magnetic field can determine the domain of the bit. The data is read off of the disk by taking advantage of a phenomenon known as the Kerr effect. When a low power laser is directed at the disc, the laser beam's plane of polarization will be rotated clockwise or counter-clockwise depending on the magnetic domain of the bit. Circuitry in the optical head can sense the polarization and interpret the bit orientation as a digital 1 or 0.

Since the intended use of optical storage is as an archive of medical images, it is obvious that WORM technology is ideal for this purpose. It is stable, writable, non-erasable, compact storage that compares well with the other technologies. Some of the various technologies, including optical data cards and recently announced 3.5" optical discs, are compared in Table 1.

TABLE 1

<u>Media</u>	<u>Capacity (MB)</u>	<u>Cost</u>	<u>Images (appr.)</u>	<u>Cost/Image*</u>
Large Archival Discs	10000	\$500	30000	\$0.015
Local Archive, 5.25"	1000	100	3000	0.03
Transfer Disc, 3.5"	100	25	300	0.08
Optical Data Card	4	2	12	0.17

\* Cost/Image only applies if the disc or card is used to saturation (completely filled).

#### G. DIN/PACS

It is important that the radiographic workstation have the capability to communicate with other devices. Aside from the cassette scanner, which must be interfaced for image transfer, other devices such as x-ray film scanners, CT, MRI, or ultrasound machines could be connected for image file exchange. The open systems interconnect (OSI) model specified by the International Standards Organization (ISO) plays a large part in network interfaces.

The main idea of OSI is simply that if all network interfacing is specified with a common model, e.g. OSI, then connecting computers from different manufacturers is simplified. OSI is *not* a description of the actual connections between computers, but is merely a *model* (composed of seven layers) by which the connections are specified. A manufacturer may use the OSI model in defining their network and still have proprietary hardware and/or software incorporated in the network. Use of the OSI model allows the person setting up the network to "mix and match" between products of many manufacturers at different layers in the network. Each of the seven layers can be viewed in theory as a "black box" which is virtually independent of the other layers. In practice there is some mixing between the layers. This is partly due to some manufacturers not explicitly following the OSI model or misinterpreting the specification.

Use of the OSI model is becoming widely accepted in the computer industry and should seriously be considered for future medical imaging networks. Currently, the medical imaging field is fragmented by powerful corporations trying to get the market to adopt their proprietary "standards" in order to gain market share. The problem with this approach is that once a network is assembled, it can only use hardware and software from one particular company since the network components are proprietary. With OSI, if the person assembling the network decides that a particular layer would be better served by components from a different manufacturer, it is possible to incorporate them in the network.

#### 1. ACR/NEMA Standard

As filmless systems become more common, it will be possible for a single control console to display images from a number of sources such as x-ray, ultrasound, CT, MRI, etc. Further, the control console could interact with the image source to recall or reprocess images as required by the diagnostic process. The variety of technical possibilities led to the development of standards for the design of interactive controls. The ACR/NEMA Standard Interface ("ACR/NEMA") defines the protocols for such controls and describes the various commands, their structure and electrical characteristics.

It is important to note that the ACR/NEMA is an interactive standard for apparatus operating over a short range, i.e., within a few meters of the control. It enables the designer to construct an imaging system so that it may be controlled by an external console or viewing station. It permits the designer of the viewing station to build a single device which can accommodate the display and control of several different image source devices. It does not define the standards for communication with a larger information and image archive system such as a digital information network, DIN, or a hospital information system, HIS.

The ACR/NEMA must be connected to a larger system via an undefined Network Interface Unit, NIU. The NIU could be built as a "minimum" device suitable for selecting and transmitting/receiving images and reports or as a device of great capability for interacting and reprocessing selected images. Of course, the capability of the complete system depends on the DIN and HIS as well as the NIU. The higher level capabilities imply filing of unprocessed images (image data) for processing according

to the demands of the the NIU signals or a means of accessing the image source via another communication branch or NIU.

The ACR/NEMA describes the complete scheme of interactive control. For those systems which will not permit interactive control, a subset of the the standard may be used. For example, if a CT system with an ACR/NEMA connector were to be used with a simple display-only console, only those portions of the standard relating to image transmission would be used. In the case of the relatively simple ARMIS scheme, the ACR/NEMA port would not be interactive by would be limited to accepting images for display which had been formatted to that standard.

There are serious and practical questions of whether the ACR/NEMA is appropriate for systems such as ARMIS. The complexity and cost of the ACR/NEMA interface hardware when interactive operation is not required may not be justified in view of alternative methods. For example, the SCSI is used for control of peripheral devices with the Macintosh or PC compatibles. Communication schemes and protocols have been developed and are in common use for the transfer of files between these computers. For the ARMIS, the intent was to accept images from other sources via a subset of the ACR/NEMA or from a SCSI interface. Although not assembled, an ACR/NEMA to SCSI interface was proposed. The scheme would permit the ARMIS control to accept ACR/NEMA images and store them via Ethernet links using any one of several standard protocols developed for other (non-medical imaging) purposes. A question arises whether the system would be simpler if the peripheral image source were made compatible with SCSI in a more direct way without the ACR/NEMA.

## 2. Ethernet

Ethernet is one of the most used network standards and has the largest installed base of any network topology. This is likely due to the fact that Ethernet is the most expandable and flexible of all networking options. An Ethernet network may start out very small, but is easily expanded and can include thousands of nodes. Since Ethernet has been standardized (IEEE 802.3), it is possible to build a network with components from different manufacturers. No single company controls Ethernet specifications.



Ethernet has a respectable bandwidth of 10 Mbps, which is quite satisfactory for network image management. This compares to the 230 Kbps bandwidth of Apple Computer's LocalTalk network standard. There are other networking options with higher bandwidths, but none enjoy the standardization and acceptance of Ethernet. There are many different wiring schemes that have Ethernet implementations. Fiber optics, thick or thin coaxial cable, and shielded twisted pair can all be used in an Ethernet network. Implementations with unshielded twisted pair cabling are foreseen for the near future. The only difference between the wiring schemes is the maximum segment length as determined by the wire size, shielding, and grounding. The maximum segment length is 1640 feet (500 meters) for standard Ethernet and 607 feet (185 meters) for thin Ethernet (also known as ThinNet or CheaperNet). The number of segments and repeaters allowed between nodes is limited to three and two respectively. With the use of repeaters or a backbone segment, an Ethernet LAN can have up to 2.5 miles (4 km) of cable and an unlimited number of segments. If network bridges are used between LANs, the network can cover an area spread over hundreds or thousands of miles. LANs are thus connected to form a wide area network (WAN). Bridges can use 56K leased lines, T1 links, digital data circuits, or public telephone lines.

### 3. ISDN

The Integrated Services Digital Network, ISDN, is a projected worldwide public telecommunications network that will service a wide variety of user needs. ISDN is a very important development in the realm of long-haul digital telecommunications. The ISDN is based on the development of digital transmission and switching technologies and their use to construct an integrated digital network (IDN). It will integrate voice and data transmission and provide structured interfaces and transmission services for the end user. The ISDN will support videotext, teletext and facsimile, as well as other current and future digital services [12].

The standard ISDN rate that will be offered to users will be 64 Kbps. A basic service of two 64 Kbps (B) channels and one 16 Kbps (D) channel with a total rate of 192 Kbps<sup>1</sup> is proposed. Although this basic rate is sufficient for services such as voice, facsimile and teletext, a high data rate service is required for image transmission. Higher-speed services may be provided by facilities such as cable TV distribu-

---

1. Synchronization, framing and overhead account for the difference in bit rates.

tion plants or may intersect with the ISDN and make use of high-capacity ISDN links for part of a transmission path. A primary service with two different rates has also been proposed. One primary service would be comprised of 30 64-Kbps B channels and 1 64-Kbps D channel with a total rate of 2.048 Mbps. The second proposed primary service option would be comprised of 23 64-Kbps B channels and 1 64-Kbps D channel for a total rate of 1.544 Mbps. The 2.048 Mbps primary service corresponds to the high-speed rate offered in Europe whereas the 1.544 Mbps primary service corresponds to the T1 transmission facility offered in the U.S., Canada and Japan. The primary interface may also be used to support another type of channel, the H channel, which can have one of several bit rates; 384, 1536, and 1920 Kbps. A customer with very high data rate demands could also be provided with multiple primary service interfaces.

## H. Software

### 1. Development Environment

The basic radiographic workstation hardware was used to develop the operating software. A list of the major hardware components follows:

- (1) Macintosh II computer w/ 8 MB RAM
- (1) Macintosh II computer w/ 5 MB RAM
- (1) 150 MB, (1) 40 MB, (1) 80 MB hard disk drives
- (2) 8-bit 13" RGB monitors
- (1) 8-bit 12" monochrome monitor
- (1) 8-bit high resolution gray scale monitor

All development of the MacARMIS application was done in the "C" language. Several programming environments were used throughout the course of the project. The initial programming effort was done under the Macintosh Programmers Workshop (MPW™) from Apple Computer (available from the Apple Programmers and Developers Association, APDA). About halfway through the project the code was transferred to the LightSpeedC™ (now ThinkC™) environment from Symantec. This was due to the availability of a source level debugger under LightSpeedC. The LightSpeed environment also tends to be easier to use and has a very fast compiler. A mock-up of the patient report and diagnosis form was developed under version 1.0.6

of the 4th Dimension (4D) database environment from Acius. Many other applications and utility programs were also used in the development of the control program. The TMON™ debugger from ICOM Simulations, Inc. was used for some of the code debugging. SCSI Tool™ from Arborworks, Inc. was used for the initial development of a SCSI driver for the optical card reader/writer. MacDraft™ from Innovative Data Design, Inc. was used for most of the technical drawings.

## 2. Control Program

The radiographic workstation control program was broken up into several independent sections in order to facilitate development. The different parts of the radiographic workstation control program are in various stages of completion. A prototype shell of the control program shows the possible menu formats. A small program for displaying 8-bit gray scale images on the Macintosh has been completed and can be used to display digital radiographs on a high-resolution monitor. A simple patient database is nearly complete and can be used to fill out report/diagnosis forms. A SCSI driver for the optical card reader/writer was just begun when work was halted on the project. Other third party companies are currently in the process of writing Macintosh SCSI drivers for the optical card reader/writers so it is only a matter of time before they become available.

There are several sections of the control program that have yet to be completed to any usable extent. Image annotation with graphic objects and/or text has not been implemented. A patient identification block cannot be attached to an image. The program will not automatically archive image sets and reports to optical storage although files can be manually copied to archival storage. There is no interface code for a phosphor cassette scanner.

### a) Main Control Shell

A prototype of the radiographic workstation main control program was written in C under the two different programming environments. The intent of the prototype was to show possible arrangements of menus and uses of dialog boxes. This was before the realization that a database environment would suit our needs (see Patient Report Form Program section below). The "code" name of the main control program is "MacARMIS."

There are several principles of the Macintosh user interface that should be examined before looking at the prototype program. These principles are responsible for much of the "look and feel" of the Macintosh interface and its popularity. The main principles behind the Macintosh interface are: ease of learning, consistency, real world metaphors, ease of use, direct control/feedback, avoidance of modes, "select, then act", graphics/analog indicators, WYSIWYG, forgiveness, and stability [13; 14; 15].

One of the key principles behind the Macintosh user interface is ease of learning. Ease of learning implies that a user, new to an application, should be able to do useful work with it in a brief period of time. Another important principle that works hand in hand with ease of learning is consistency. If applications that do similar things, do them in the same manner, then learning how to use a new application is much easier. An application can also be locally consistent in that a command does not mean different things at different times in the program (ie. a command does not change function).

A third principle is that of real world metaphors. This principle refers to making the application's objects and the use of the application similar to how objects would appear and how they would be manipulated in the real world. Another important principle is that of ease of use, ie. being able to use shortcuts for operations that are used a great deal.

The principle of direct control and feedback means that the user should appear to be in control of the program. Events should occur as the direct result of the users actions. Whenever the user does something, then the program should also give some sort of feedback so that the user knows what has occurred as a result of their actions.

Avoidance of modes is another principle that is used in conjunction with real world metaphors. Modes are used in an application to define and restrict what the user may do at a given moment. People do not work that way in the real world, so the use of modes should be kept to a minimum.

The “select, then act” principle refers to the *noun-verb* technique used by the Macintosh. The user selects an object first, then chooses a command to act upon the object. This is in contrast to the *verb-noun* technique in which a command is issued before the object is specified.

The use of graphics and analog indicators is an integral part of the Macintosh user interface. Graphics can convey information and ideas much more clearly than text can. Analog indicators are easier to understand (than digital indicators) and have a high enough accuracy for most people.

WYSIWYG (What You See Is What You Get — “wizzy-wig”) means that a printed document will appear the same as it does on the screen.

Yet another principle is that of forgiveness. Actions should be undoable and if that is not possible, then undertaking serious actions should be preceded by a warning alert box (a box containing a warning or additional information which should be noted) allowing the user to reconsider.

The last principle is that of stability. A stable application maintains the same menus while it is running, uses the same terminology throughout the program, and has dialog boxes which are similar in style. An application should strive to maintain a familiar environment for the user.

When the main control program is launched (started up - either by double clicking on its icon or by selecting its icon and choosing Open from the File menu), a list of menus are displayed along the upper border of the computer screen in the menu bar. From left to right the menus are: “Apple”, File, Edit, Annotate, Algorithm, Image, and Preferences. The commands available under each of these menus will be described in the menu sections below. It is noted in the following sections that the “Apple”, File, and Edit menus are standard in most applications. Two primary reasons for this are: to correctly support Desk Accessories, and, to maintain interface consistency across Macintosh applications.

#### (1) Apple Menu

The Apple menu which is standard in most applications is also included in the main control application. This menu simply allows one to access desk accessories (DA's) from within the application so that one needn't quit the program to do some simple task. For example, some of the desk accessories currently available include calculators, notepads, Finder substitutes, equation construction sets, mini drawing pads, alarm clocks, games, etc... An example of the Apple menu is shown in Figure 5.

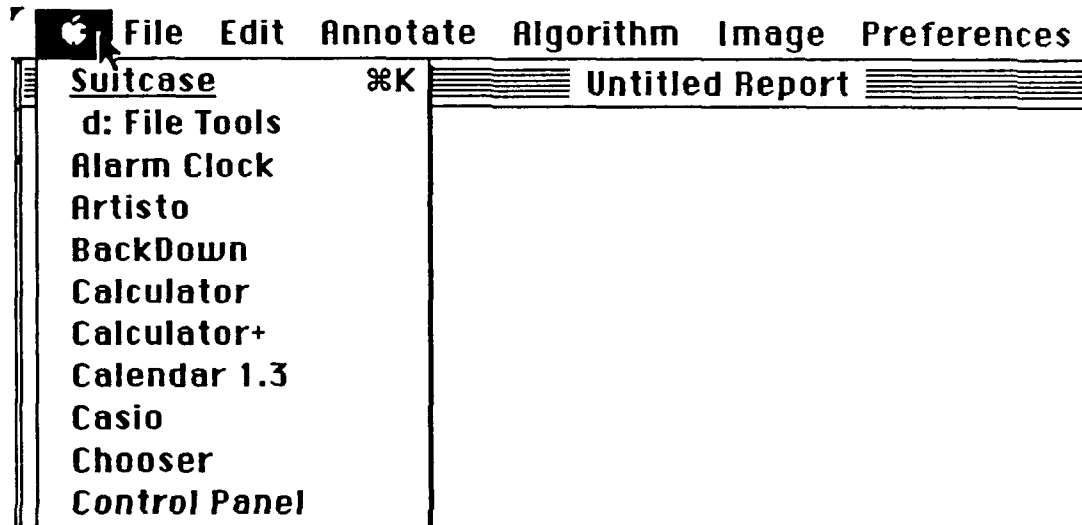

Figure 5. Example Apple Menu

The About MacARMIS... and Help... commands are also included in the Apple menu. The About MacARMIS... command brings up an alert box which simply states the name and version number of the MacARMIS application. The box also includes copyright information, author information, etc... Selecting the Help... command also brings up an alert box which allows the user to obtain information about how to use the MacARMIS application. The alert box contains a scrolling window with a list of topics that can be explained. The user need only select and open the topic they want to read about and the alert box will display it. There are buttons in the box which allow the user to go back to the topic list or to exit the help section.

## (2) File Menu

The File menu, which is also standard in most Macintosh applications, is the next menu in the menu bar. The File menu contains those commands which pertain to handling files in the application. The commands available in the File menu include New, Open..., Close, Save, Save As..., Revert, Page Setup..., Print, and Quit as shown in Figure 6 and described below.

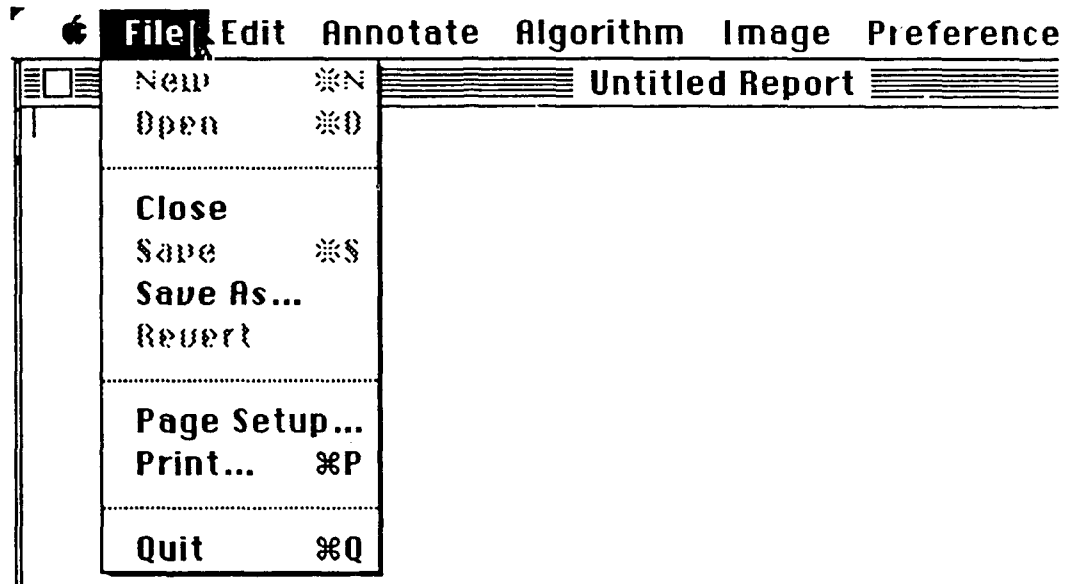

Figure 6. Example File Menu

The New command is typically used for opening a new file for editing. In the MacARMIS application, New is used for opening up a new blank patient report form. When the New command is issued, an empty report form will be opened on the computer display. The report form will be in the format that was last selected via the Report... command in the Preferences menu. Several fields of the new report (hospital info, time, date, etc...) will be automatically filled in by the MacARMIS program.

The Open... command is used for opening an existing report or image document for editing or annotation. After selecting the Open... command a standard Finder style dialog box will appear. The user then selects the document that they wish to open for display (either a report or an image). If the selected document is a report, then it is displayed on the computer's control screen. If an image is selected, and there is more than one display monitor, then another dialog box will appear allowing the user to select which monitor

the image is to be displayed upon. The set of display monitors can be logically arranged in a sequence and the program set up so that the default monitor selected for image display will be the next monitor in the sequence. (See description of the Display... command in the Preferences menu section.)

The Close command simply closes a report or image document window. Since there may be more than one document open at the same time, the Close command only affects the currently active window. The active window can be distinguished by its highlighted border. A window can be made active by simply clicking the mouse while the cursor is within the borders of the window. If there have been changes to the report or image since it was opened then an alert box will appear allowing the user to save or discard changes to the document or to cancel the close operation.

The Save command saves the document in the currently active window. If the document is a report then the document is simply written to the computer's hard disk. If the report is a new document, the standard Save As... dialog box will appear asking the user to name the new document (see below). If the document is an image, the Save command will only update the annotation information since the image itself may only be "changed" when it is first read into the computer and initially labeled.

The Save As... command is used for saving a copy of the document in the active window. (Currently the Save As... command will not be supported for copying image files.) When this command is selected, the standard dialog box appears. The dialog box contains a Finder section, Save and Cancel buttons, and a naming field. The user fills in the name of the copy or original, selects the destination folder to contain the document (optional), then presses the Save button. The Cancel button can be used to cancel the operation and quit out of the dialog box.

The Revert command is used to throw away all changes to the file since the last save. The file "reverts" to the last saved version. An alert box will allow the user to reconsider invoking this command and losing all additions to the document.



The Page Setup... command is used for setting up the printer parameters for printing a document. Selecting this command brings up a standard dialog box allowing the user to select such things as paper size, orientation, reduction or enlargement, etc...

The Print... command simply prints out the active document. The standard print dialog box will allow the user to select number of pages, document alignment, style, etc...

The Quit command is used for quitting out of the MacARMIS application program.

### (3) Edit Menu

The Edit menu contains those commands used for editing the text and graphics of reports and images. The Edit menu also follows the Macintosh standard used by most applications. The commands included in this menu are: Undo (Redo, Can't Undo), Cut, Copy, Paste, and Clear. The commands are shown in Figure 7 and described below.

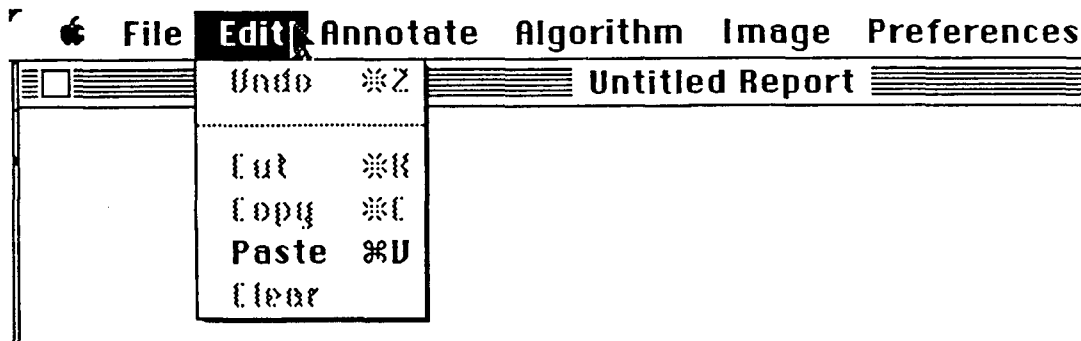

Figure 7. Example Edit Menu

The Undo (Redo, Can't Undo) command can have several effects depending on the context in which it's invoked. If the user has just deleted (cut, copied, pasted, etc...) a selected portion of text, then invoking Undo brings the deleted text back. If the user then pulls the Edit menu down, the first command will be Redo. Invoking this command will "undo the undo". In this case the previously deleted and restored text will again be deleted. The user may

toggle between the Undo and Redo as many times as they desire. If a given operation cannot be undone, then the command will read Can't Undo and will be grayed out after the operation. The Undo, Redo, and Can't Undo commands work on graphic elements (image annotations) as well as text in a report.

The Cut command allows the user to "cut" a selected portion of text or a graphic element from a document. This command differs from delete or Clear in that the object is put in the clipboard (a memory location set aside for temporarily storing objects), replacing whatever was previously stored there.

The Copy command works similar to Cut in that a copy of the selected object (text or graphic) is placed in the clipboard, replacing the previously stored object. The difference is that the selected object is not deleted from the document.

The Paste command is used to retrieve objects from the clipboard. If a text document is active when Paste is invoked, the object stored in the clipboard is pasted into the document at the position of the text I-beam (an I-shaped cursor used for inserting text in a document). If a graphic document is active when Paste is invoked, then the object in the clipboard is pasted to the last active portion of the document. When the object appears in the graphic document it will be surrounded by a box with handles (little black squares on the border of a selected object by which the object can be resized) which means that the object is selected and can be moved to any desired location in the document by simply dragging it.

The Clear command is similar to Cut in that the selected text or graphic element is deleted from the document. The difference between the two is that the object is not saved into the clipboard. Thus the Undo command will not restore the object. The Clear command has exactly the same effect as deleting an object with the delete (backspace) key.

#### (4) Annotate Menu

The Annotate menu is used to label a region of interest (ROI) on an x-ray image. The commands contained in this menu allow the user to annotate an image by outlining regions of interest and labeling them with text. The commands are divided into four sections by function. The four sections are: overlay toggle, graphic annotations, text annotations, and line characteristics. The overlay toggle section consists solely of the Hide/Show Overlay command. The graphic annotation section is comprised of the Rectangle, Circle, Oval, Polygon, and Region commands. It may be possible to display the graphic annotation commands as icons in a palette. Choosing the desired command would be simpler for the user as the function of each command would be clear. The text annotation section consists of the Line, Diagonal, and Text commands. These commands may also be displayed as icons. The line characteristics section comprises a single command, Line Characteristics.... Since the graphic annotation commands, as well as the text annotation commands, are used to draw various shapes on the screen, they may be referred to as "tools" in the following sections. For these sections, the words "command" and "tool" are used interchangeably. All of the commands in the Annotate menu are shown in Figure 8.

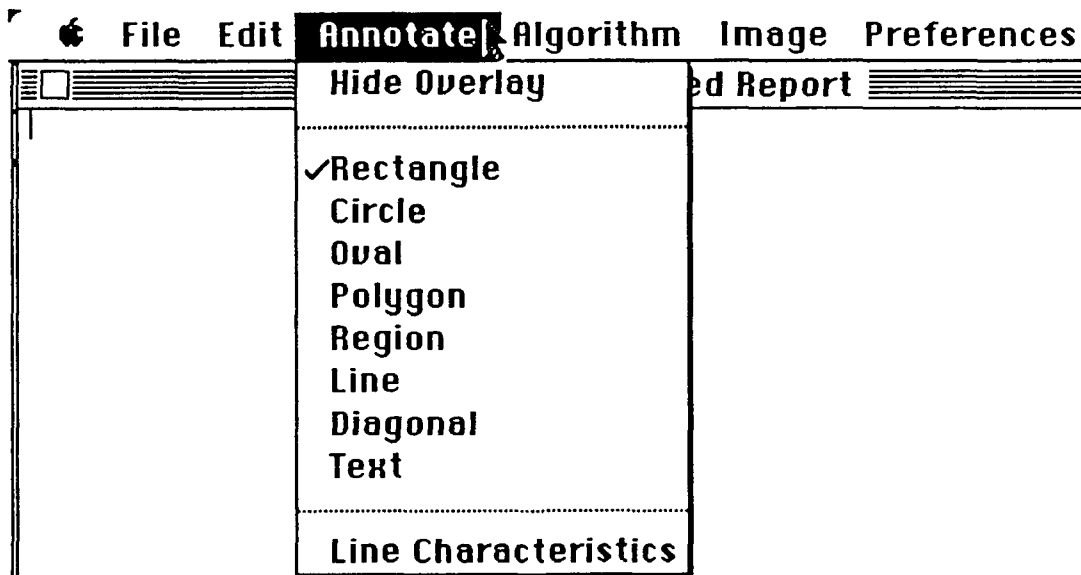

Figure 8. Example Annotate Menu

The Hide/Show Overlay command functions as a toggle switch between two states of image display. When the command appears as Hide Overlay then

the program is in the display overlay state (see Figure 8). This means that all annotations to the x-ray image are visible. If the Hide Overlay command is then selected, all annotations will be concealed and the command will change to read Show Overlay as shown in Figure 9. Selecting the Show Overlay command will again make the annotations visible.

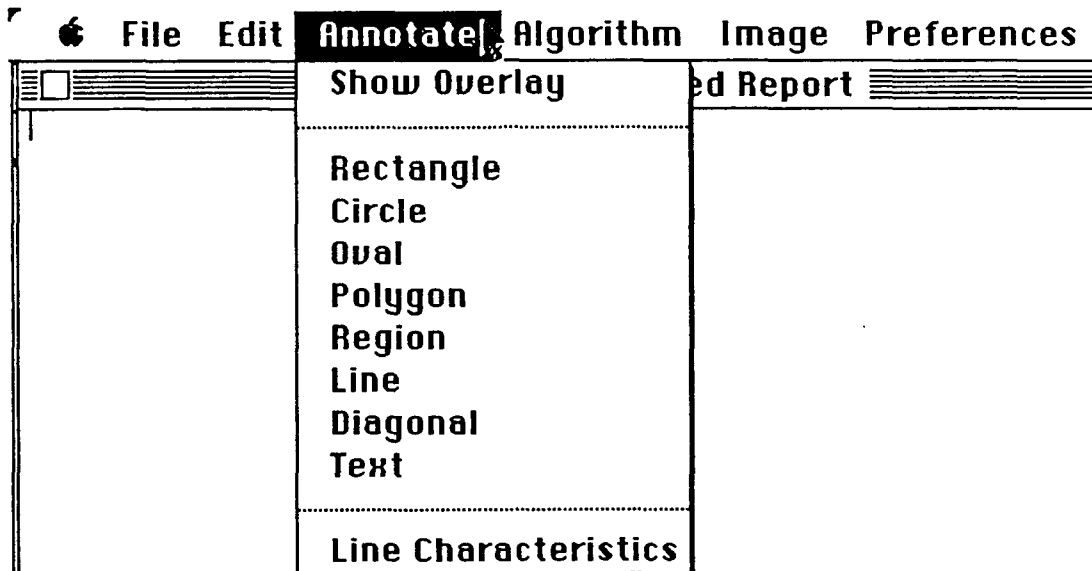

Figure 9. Show Overlay Command

All of the graphic and text annotation commands are used in a similar manner so the description of the Rectangle tool in this section can be applied to the rest of the tools (Circle, Oval, Polygon, Region, Line, Diagonal, and Text).

In order to place a rectangle around a region of interest on an image, the user merely selects the Rectangle tool and draws the rectangle. When the Rectangle tool is selected, the cursor changes from the arrow cursor into a cross cursor. This indicates that the computer is ready to draw an object. The object is drawn by dragging from one corner to the diagonally opposite corner. The thickness of the lines making up the rectangle can be set in the hierarchical Line Characteristics menu described below.

If after selecting one graphic tool, the user decides that they want to draw a different object, then the object shape can be changed by simply selecting

another tool. A checkmark next to a command in the graphic annotation section of the Annotate menu indicates the currently active tool (see Figure 8). If the tools are represented as icons in a palette, then the active tool will be shown in inverse video.

Once an object has been placed, it's position can be further adjusted by selecting it and dragging it to the desired location. The object size can also be adjusted by selecting the object and resizing it by the handles located at the corners of the object. An object can be deleted by simply selecting it and then using Clear from the Edit menu or by pressing the delete key. An object can also be Cut or Copied to the clipboard and then Pasted somewhere else.

The line characteristics command is available for adjusting the characteristics of the various objects. The width of lines and line terminators such as arrows will be user configurable via this command. It may also be desirable to allow the user to set the size and style of annotation text.

#### (5) Algorithm Menu

The x-ray technician uses the Algorithm menu to choose the type of algorithm employed when acquiring an image from the cassette scanner. The menu contains fifteen different algorithms, each of which is individually described below. To select a particular algorithm or algorithms to use while acquiring an image from the cassette scanner, the user merely selects the algorithm(s) from the menu. A check mark will then appear next to the selected algorithm(s). An algorithm can be deselected by simply selecting it again. The checkmark will then disappear. The Algorithm menu appears in Figure 10.

The particular implementation of each algorithm is not explained here as they were never completely formulated. Due to the algorithms' dependence on the hardware of the phosphor screen scanner, the specific implementations would have been decided by the subcontracting party. The algorithms shown are merely a suggested minimum configuration.

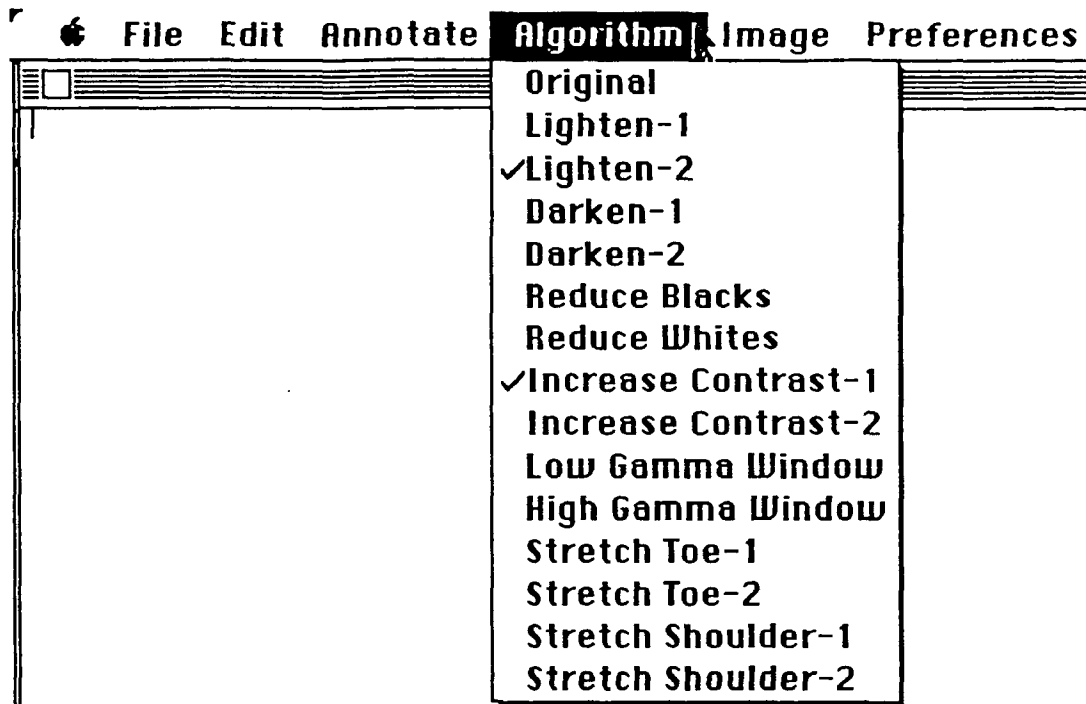

Figure 10. Example Algorithm Menu

(6) Image Menu

The Image menu is used for loading images from the cassette scanner and storing images to the hard disk. The menu shown in Figure 11 has two commands which are described below.

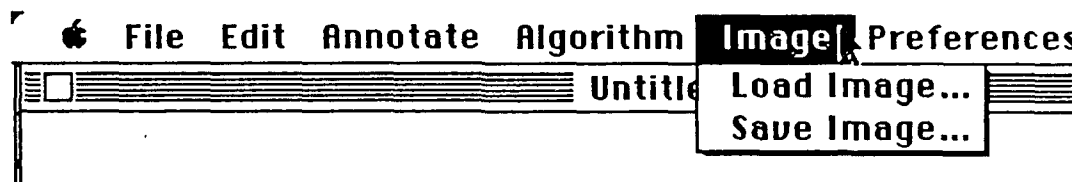

Figure 11. Example Image Menu

The Load Image... command is used for transferring an image from the cassette scanner to the computer and displaying it on a monitor. When this command is selected, a standard Finder dialog box appears allowing the technician to choose which image to load from the scanner. After an image has

been selected, and the Load button pushed, then another dialog box may appear requesting the technician to choose a monitor on which to display the image. This second dialog box only appears if the display preference (Display... command from Preferences menu) has been set to query the user.

In order to save an image from the cassette scanner as it is displayed on a monitor the technician uses the Save Image... command. This command will bring up a dialog box allowing the technician to label the image with the required identification information. The technician fills in the empty fields in the identification record and then uses the Save button to save the image.

#### (7) Preferences Menu

The preferences menu contains those commands used for setting up the defaults that are used by the MacARMIS application. The commands are shown in Figure 12 and are described in detail below.

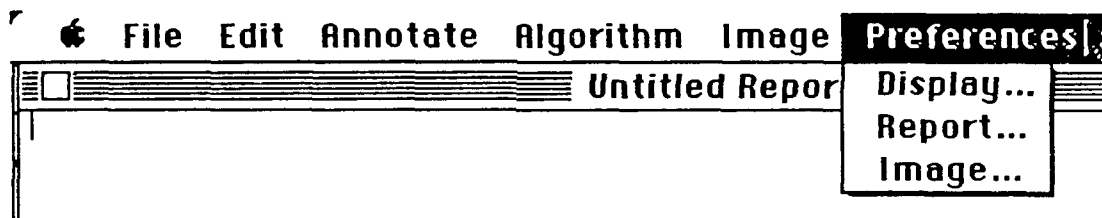

Figure 12. Example Preferences Menu

Choosing the Display... command will bring up a dialog box for display preferences. A list of display sequences allows for determining where the images will be displayed when they are loaded from the scanner or are opened from a Digital Data Card (DDC) or the computer's hard disk. The possible choices are: Query User, Cycle Monitors, and Next Free/FIFO. The Query User radio button will allow the user to choose the display monitor whenever an image is loaded or opened. If the Cycle Monitors radio button is chosen then the program will simply display an image on the next monitor in sequence. If there is an image on the monitor next in the sequence then the program will check to see if it is an unlabeled image (ie. fresh from the cassette scanner). If so then the program will skip that monitor and continue searching

for a eligible monitor. If none of the displayed images have been labeled yet then the program will put up an alert box before it overwrites the oldest image with the new image. If the Next Free/FIFO radio button is chosen then the program will display an image on any display monitor which is not currently in use. If all monitors are in use then the image will be displayed on the monitor with the oldest labeled image on it, replacing the old image as described above. A reloaded image section allows the user to select between two choices for redisplay of a reloaded image. The two choices for this section are Query User and Last Used. If the Query User radio button is selected, then every reloaded image will require the user to choose a monitor for redisplay. If the Last Used radio button is selected, then a reloaded image will be displayed on the monitor previously used for that image.

The Report and Image preferences are not explained here as they have yet to be fully formulated.

#### b) Image Display Program

The image display program has been successfully used to display 1024 x 1280 x 8-bit gray scale images on a high resolution VMI monitor. The program can recognize two different image file formats: TIFF (Tag Image File Format) and data stream (unformatted). Support for Apple's picture file format, PICT2, should also be considered in order to maintain compatibility with other Macintosh imaging programs. In order to display an image, the program requires the image width (in pixels), the image length (in pixels), and the image data. TIFF provides for many other image specifications, but if all images are assumed to be 8-bit gray scale, the additional capabilities are not required.

TIFF is designed to be a machine independent file format for storing and transferring scanned images. It was developed by Aldus Corp. in cooperation with several other scanner software and hardware companies. Although not intended to be a general document interchange standard, TIFF can be useful for the MacAR-MIS image editing application. As stated in the TIFF specification [16], "The primary design goal [of TIFF] was to provide a rich environment within which the exchange of image data between application programs can be accomplished." To this end, TIFF can take advantage of the varying capabilities of scanners and simi-



lar devices. TIFF is designed to be a superset of existing image file formats for pixel-based devices and application programs. Although TIFF is independent of specific operating systems, filing systems, compilers, and processors, it assumes that the storage medium supports something like a byte stream file. A byte stream file is defined as a sequence of 8-bit bytes, where the bytes are numbered from 0 to N.

c) Patient Report Form Program

As stated before, the patient reporting program is based upon the 4D database environment. A database environment allows the use of integrated reporting tools and the capability of searching and sorting on the various fields. Although a realistic use of the radiographic workstation is as an integrated part of a much larger RIS or HIS, a standalone system could be useful. Even though the 4D environment is self sufficient in terms of database capabilities, there are "hooks" available for integration with other programs. If a needed capability is not offered by the 4D environment, an external code segment (XCMD or XFCN) written in another language (C, Pascal, etc.), can be directly linked into the database. Links for SQL are also available for integration with SQL-based databases running on larger computer systems. Late in the project, it was realized that the entire radiographic workstation control program could be based upon the 4D environment.

An example screen version of a report form from the database is shown in Figure 13. The report fields can be edited by simply tabbing from one to the next or by simply clicking in it with the mouse. 4th Dimension has a very flexible layout design facility, so report forms for the screen or printer can be customized to most user's requirements. Other useful capabilities include automatic dynamic relations, data import and export, quick report generation, fully customizable menus, a password system, multi-user support, and a Pascal-like programming language.

PATIENT DATA				
Last Name	First	Middle	Age	Sex
Grenzow	Frank	C	31	
Street			Social Security Number	
Old Sauk Road			123456789	
City	State	Zip Code	Pregnant?	Date
Madison	WI	53717		7/7/88
EXAM DATA				
Exam Requested MRI scan				
Requested By Dr. NoGood			Date Requested 7/7/88	
Send Report To Dr. DoGood			Phone No. 2349873	
Reason For Request pain in the neck (complaints and findings)				
Radiological Report			Report Date 7/7/88	
Diagnosis: faulty neck - replace immediately!				
Image Data		current	previous	
images	view	images	view	
	1 anterior neck		1 anterior neck	
	2 posterior neck		2 posterior neck	

Figure 13. Patient Report Form

The database requires some work before it could be used in a real-world situation. Report forms can be filled out and simple searches and sorts may be executed. None of the image display or manipulation facilities have been integrated with the database. A new and much improved version of the 4D database development environment (version 2.0) is now available. It is highly recommended that the

new version be used for any future development. A utility is available which will convert any prior version databases to the new format. Some code modification may still be required after conversion.

d) Optical Card Reader/Writer SCSI Device Driver

An initial effort was made to write a SCSI device driver for the Olympus optical card reader/writer. The SCSI Tool program was obtained to aid in the development effort. With the use of SCSI Tool, several tracks of an optical card were successfully addressed and accessed. An example of a simple SCSI driver was also obtained from Apple computer and studied. In the Macintosh, the SCSI hardware is accessed through a set of ROM toolbox routines collectively called the SCSI Manager. Apple has notified developers that the SCSI Manager will change significantly with the next release of system software (System 7.0). Since device drivers are fairly hardware specific, they are usually written by the device engineers. Other companies are also in the process of developing drivers for the optical card reader/writers. For these reasons, work on the Macintosh SCSI driver was not completed.

3. Data Compression

Because of the current limitations of writing speed and data capacity of the optical data cards and the desirability of conservation of transmission bandwidth, image data must be compressed. The referring physician informational requirements are met 90% of the time with patient examinations consisting of up to 8 images and several pages of text. Each image is displayed as 1024 x 1280 x 8 bits and therefore consists of 1.3 MB of data. To store 8 images on a card, approximately 10.5 MB of storage capacity would be required. Since a card will hold only 2.9 MB of data, an algorithm with a minimum compression ratio of 4:1 is required. Two cards would be used if the need to store more images is required. Another consideration is that both the compression/expansion processes must be within the cost and processing time constraints of the Macintosh II and AT-compatible computers (used for the independent viewer).

Data compression algorithms fall into two categories: spatial domain and frequency domain. An example of a frequency domain algorithm that is currently

being used in many image processing applications is the fast cosine transformation (FCT). This algorithm gives a high quality image with compression ratios of 10:1 and approaches the theoretical optimum in its energy compaction properties [17]. However, several problems arise when using the full frame FCT algorithm. It is hardware intensive, which prohibits its use on the Apple Macintosh II and IBM-AT for this application. Secondly, if an error were to occur during data transfer, this error could ramify and render the expanded image useless.

A spatial domain algorithm that was examined is the Delp block truncation coding (BTC) scheme [18]. The performance of BTC is comparable to the FCT for compressed data in the neighborhood of 1.5 bits/pixel, but is computationally less intense [19]. BTC compression usually results in an inherent "blockiness" of the image. A method was developed for convolving the bit map of the BTC image using a low pass filter to improve the quality of the image. This scheme, called Filtered Block Truncation Coding, FBTC [20], produces acceptable images after expansion. Implementation of the filter processing was made feasible by the addition of an inexpensive floating-point digital signal processor (DSP) plug-in board to the independent viewer.

#### a) Block Truncation Coding

The BTC technique is usually restricted to blocks of 4 x 4 pixels on which a one bit per pixel nonparametric quantizer is calculated. This quantizer is used to preserve the mean and standard deviation of the 16 pixels in each 4 x 4 block. The nonparametric quantizer is a 4 x 4 matrix, called the bit map, where a value of 1 is assigned to a location if the corresponding pixel in the original 4 x 4 block is greater than or equal to the mean and a 0 otherwise. This restriction will produce a data compression of 4:1 if the mean and standard deviation of each block are each assigned a byte. The image is expanded by replacing the "1's" of the bit map with the amplitude value of the mean plus the standard deviation times a weight. The "0's" are replaced with the mean minus the standard deviation times a weight.

The BTC algorithm implementation first partitions the original  $M \times K$  image into contiguous 4 x 4 blocks of 8-bit pixels. Then for each block, if  $X_1, X_2, \dots, X_m$  are the pixels of that block where  $m = 16$ , we calculate the first and second

sample moments and the sample variance:

$$\bar{X} = \frac{1}{m} \sum_{i=1}^m X_i \quad (1)$$

$$\overline{X^2} = \frac{1}{m} \sum_{i=1}^m X_i^2 \quad (2)$$

$$\overline{s^2} = \overline{X^2} - \bar{X}^2 \quad (3)$$

A threshold  $X_{th}$  for the one bit quantizer is set to  $\bar{X}$ . This will force the preservation of the above mentioned local statistics if we replace the  $X_i$ 's in the local block as follows:

$$\text{if } X_i > \bar{X}, \text{ output} = b$$

$$\text{if } X_i < \bar{X}, \text{ output} = a$$

$$\text{for } i = 1, 2, \dots, m$$

where

$$a = \bar{X} - \bar{s} \sqrt{\frac{q}{(m-q)}} \quad (4)$$

$$b = \bar{X} + \bar{s} \sqrt{\frac{(m-q)}{q}} \quad (5)$$

and  $q =$  number of  $X_i$ 's greater than  $\bar{X}$ .

To compress the image, each 4 x 4 block is assigned two bytes which carry the 4 x 4 bit plane consisting of 1's where  $X_i$  is replaced by  $b$  and 0's where  $X_i$  is replaced by  $a$ .  $\bar{X}$  and  $\bar{s}$  are also each assigned a byte. Therefore, 16 bytes of the original image are replaced by 4 bytes in the compressed image.

A minimum amount of "blockiness" is usually inherent in images processed using the BTC technique, however, the properties of the human visual system tend to mask this effect. Therefore, there is little need to present precise amplitude values in small areas but it is necessary to preserve gradients. Although Delp et al. [18] reported no "blockiness" on 256 x 256 x 8-bit images, blockiness was clearly visible when this algorithm was applied to an 864 x 708 x 8-bit image of the brain and the image was viewed on a high resolution monitor. The reason for this "blockiness" is that only two values are assigned to each 4 x 4 block of pixels during expansion of an image, and therefore, no fine gradations are reproduced.

b) Filtered Block Truncation Coding

The question arises as to how the BTC can be modified to reproduce fine gradations in each block. It was observed that the BTC was not taking advantage of the fact that neighboring pixels of an image are highly correlated [21]. To obtain a Filtered Block Truncation Coding (FBTC) algorithm this correlation was used to modify the weights in the BTC that are used to reconstruct the pixels in the expansion algorithm. To increase the sub-gradients, a global bit map of the entire image is formed from the local 4 x 4 bit maps. The global bit map is spatially convolved with a low pass filter to give the different weights used in calculating the values for the local 4 x 4 blocks in the expanded image. This creates a sub-gradient which results in a more pleasing image while introducing no new artifacts [22].

The explanation behind the FBTC is as follows: If the 4 nearest neighbors of the pixel that is to be generated have the same bit map value as the bit map value of that pixel, then the standard deviation used to construct that pixel is weighted by 1.25. If 3 nearest neighbors have the same value, then the standard deviation is weighted by 1.00. If 2 nearest neighbors have the same value, then the standard deviation is weighted by 0.75. If only 1 neighbor has the same value, then the standard deviation is weighted by 0.50. And, if none have the same value, then the standard deviation is weighted by 0.25. These weighting factors were arrived at after experimental evaluation of various other values.

The FBTC algorithm implementation constructs an  $M \times K$  image bit map of the local  $4 \times 4$  bit maps and reconstructs each point by convolving the global bit map with the following filter:

$$\frac{1}{4} \begin{pmatrix} 0 & 1 & 0 \\ 1 & 0 & 1 \\ 0 & 1 & 0 \end{pmatrix} \quad (6)$$

This produces a weighting factor  $w_{i,j}$  to be used in the expanded image as follows:

$$y_{i,j} = \bar{X} - \bar{s}(1.25 - w_{i,j})\sqrt{\frac{q}{(m-q)}} \quad (7)$$

if the  $i,j$  location of the image bit map is 0 and

$$y_{i,j} = \bar{X} + \bar{s}(1.25 + w_{i,j})\sqrt{\frac{(m-q)}{q}} \quad (8)$$

if the  $i,j$  location of the image bit map is 1.  $\bar{X}$  and  $\bar{s}$  are the local mean and standard deviation which are assigned to the  $4 \times 4$  block containing the  $i,j$  location of the original pixel.

It has been argued that irreversible data compression coding schemes should not be applied to medical images. However, since the initial acquisition of a medical image is not perfect it should be obvious that restriction to error-free coding schemes is putting conditions on the process that will not improve the diagnostic quality of the original image. Radiologists who have reviewed the FBTC process have found the images acceptable in terms of diagnostic quality. This conclusion is supported by other researchers in the field of medical image processing who have found irreversible coding schemes to be acceptable [23].

Data compression schemes that divide an image into sub-blocks have an inherent "blocky" artifact. In this application a  $3 \times 3$  kernel [18] is convolved with a global bit map formed from the  $4 \times 4$  bit maps of the BTC. The result of this convolution is a minimal increase in the contrast gradient over the image, but the

number of gray levels is noticeably increased, thus reducing the blocky artifact inherent in the BTC scheme. This is clearly evident in Figure 14 which shows a small enlarged section (16 times) of a brain image that was compressed and expanded using both the original BTC and the FBTC. Images obtained by using the FBTC scheme are visibly superior to the original BTC algorithm since the artifacts inherent in the BTC image reconstruction are diminished. This improvement is computationally fast and therefore practical for compression of large image fields.

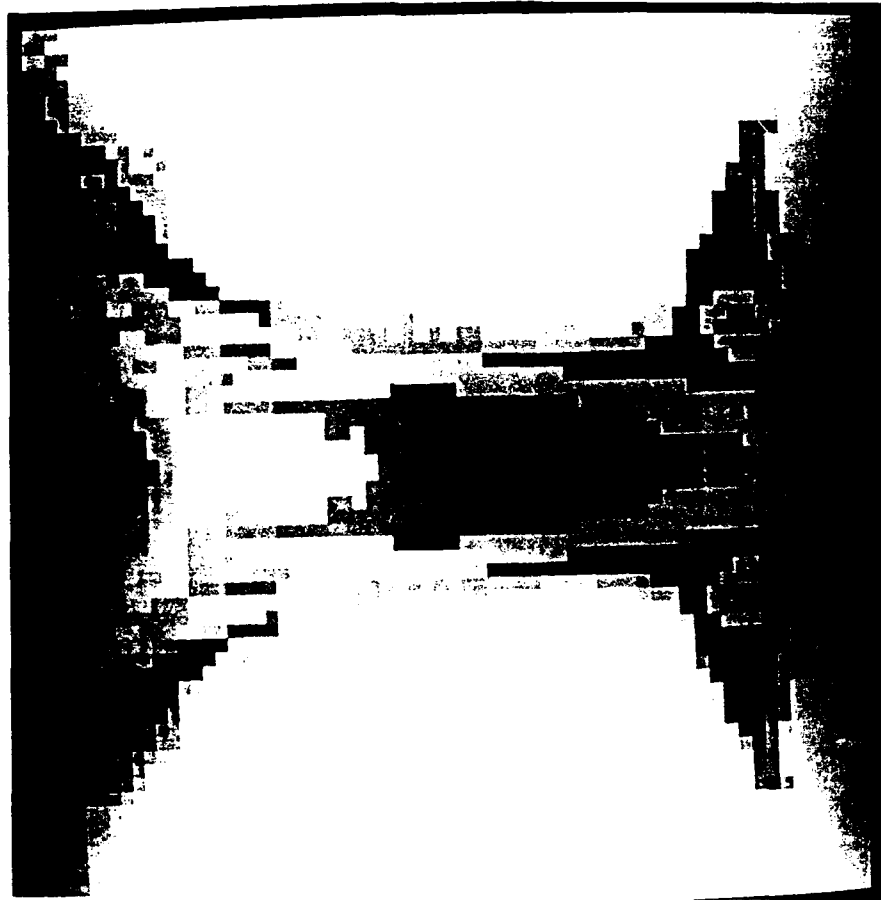

Figure 14. Original BTC (top) vs. Filtered BTC (bottom)



## VIII. Independent Viewer

### A. Operation of the System

The independent viewer contains the optical data card reader, high resolution monitor, a single board computer, control board for the optical card reader, video board for the monitor, floating-point DSP accelerator board, extended RAM board and a program ROM board. The four button control (select, up, down, overlay), as shown in Figure 15, is used instead of a keyboard. When the system is turned on, an introductory screen appears as illustrated in Figure 16. After a data card has been inserted, the directory of the card is read into RAM. The display will show the patient identification and a catalog of images on the card (see Figure 17) within the first few seconds. The up and down arrow buttons are used to step through the catalog or to scroll through long reports. The select button is used to select the report or one of the images for display or to return to the catalog after viewing an image or report. The overlay button toggles display of the annotation overlay. The keypad control software is interrupt driven to minimize system response time to the user's actions.

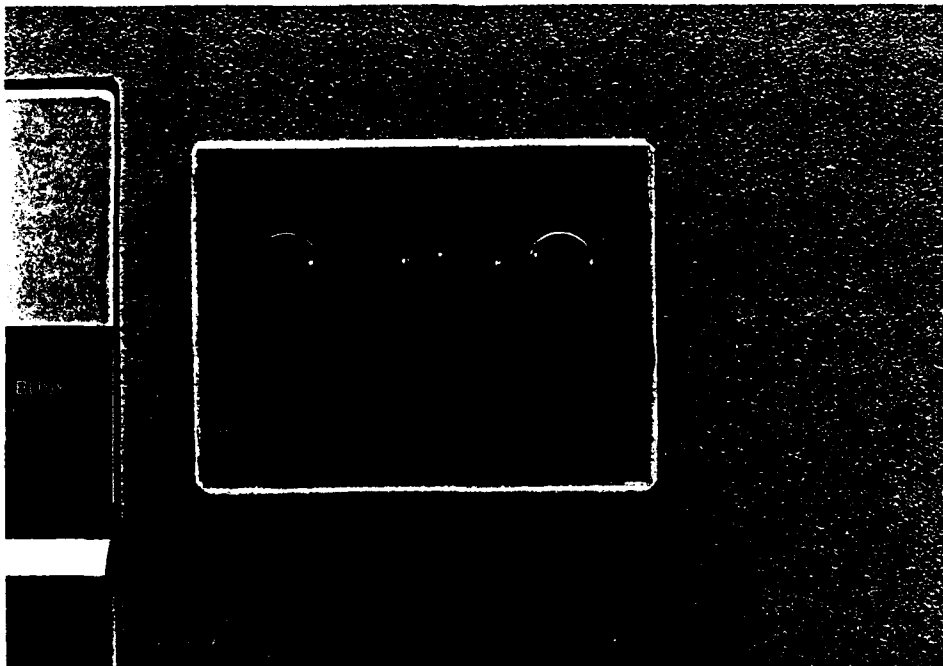

Figure 15. Independent Viewer Four Button Control

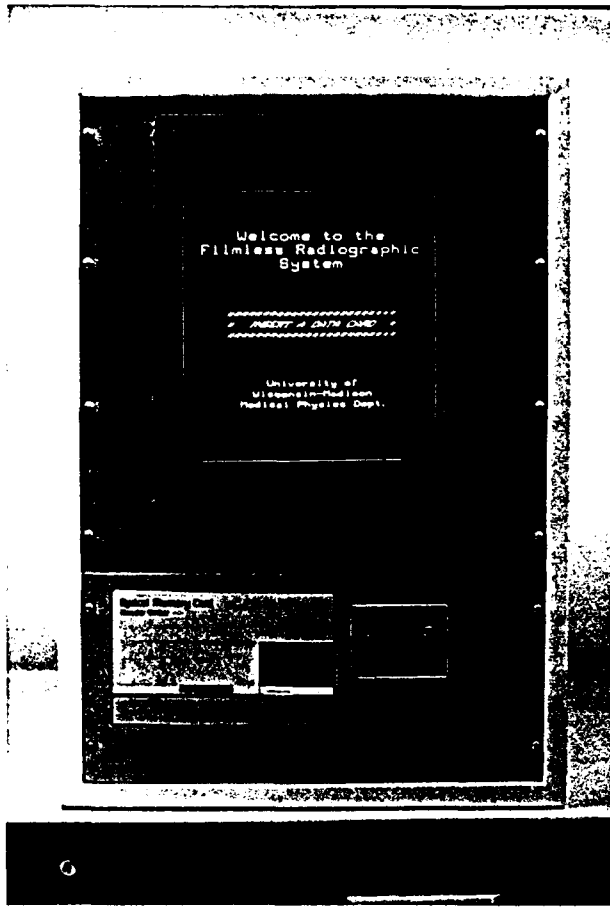

Figure 16. Independent Viewer Introductory Screen

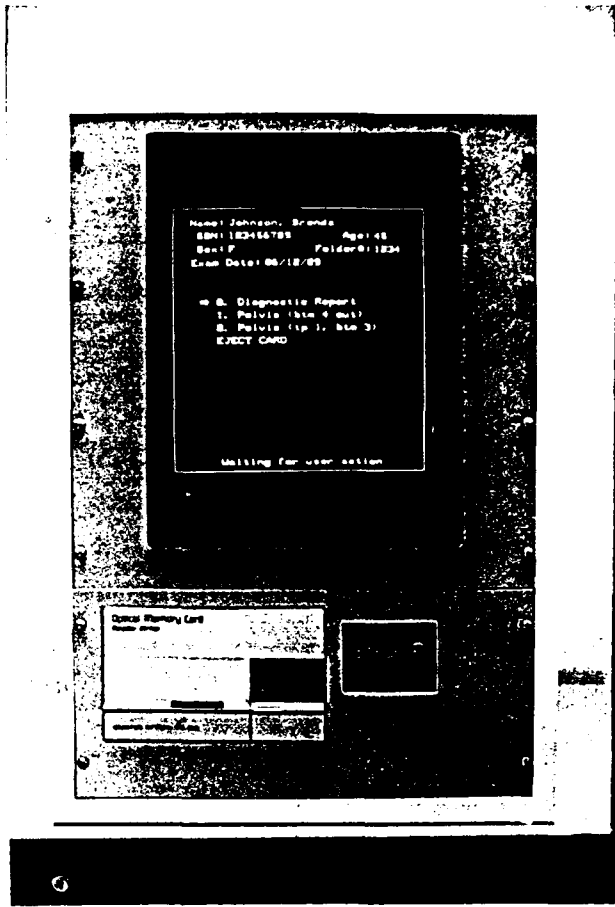

Figure 17. Independent Viewer Patient Card Catalog

After the catalog is displayed, the compressed image files are sequentially copied into RAM. This process is interruptible so that if the user selects an image file that is not yet in RAM, the system will immediately start copying the selected file. Image files are continually copied until they are all in RAM, even if the report or an image file is being displayed on the monitor. At present, the copying process requires almost 90 seconds per image. Future improvements in the compression algorithm and faster card reader/writer devices should reduce this time to under 10 seconds. Once an image has been completely copied to extended RAM it can be expanded and displayed. Image expansion takes place between extended RAM and video RAM unless the image file header indicates an uncompressed image [24]. The expansion process requires approximately 6 seconds, the image is displayed on the monitor as it is expanded.

The independent viewer is a display-only device and does not permit editing. An alternate version of the viewer has been designed to drive two monitors; a second monitor and video board are the only additional hardware requirements. An example report file is

shown in Figure 18. Example x-ray images taken from an optical data card are shown in Figure 19, Figure 20 and Figure 21.

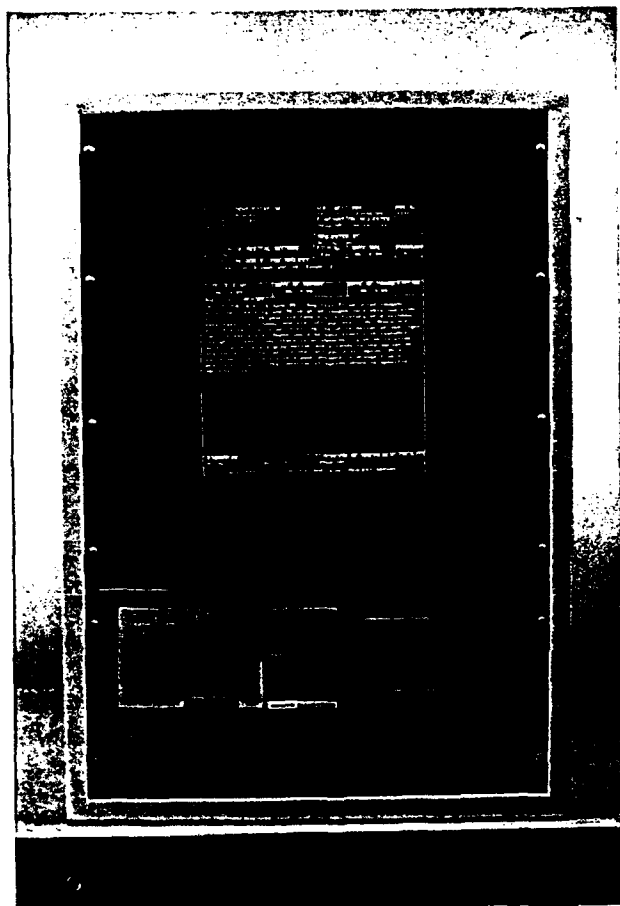

Figure 18. Patient Report File



Figure 19. Pelvis Image

Because a filmless radiography installation will have many independent viewers and few image sources, the cost of the independent viewer must be kept low [25]. The concept is that independent viewers will be used in the same way as x-ray film illuminators are now used: in doctors' offices, in the surgical suite, in the clinics, etc. The use of a low cost AT-compatible single board computer in the independent viewer assures a large source of inexpensive peripheral boards. Many users will not want to learn computer operating procedures thus extreme simplicity is essential and possible. This is the motivation for use of a four button keypad in place of a full-fledged keyboard.

An external keyboard, hard disk and control monitor were used during development of the hardware and operating system. As the operating system was refined, it was stored in the external hard disk, tested and then uploaded onto the ROM board. The ROM board obviates the need for a hard disk and keyboard in the final assembly. The operating system is written in C and can be modified by UV erasure and subsequent programming of the ROM board.



Figure 20. Skull Image

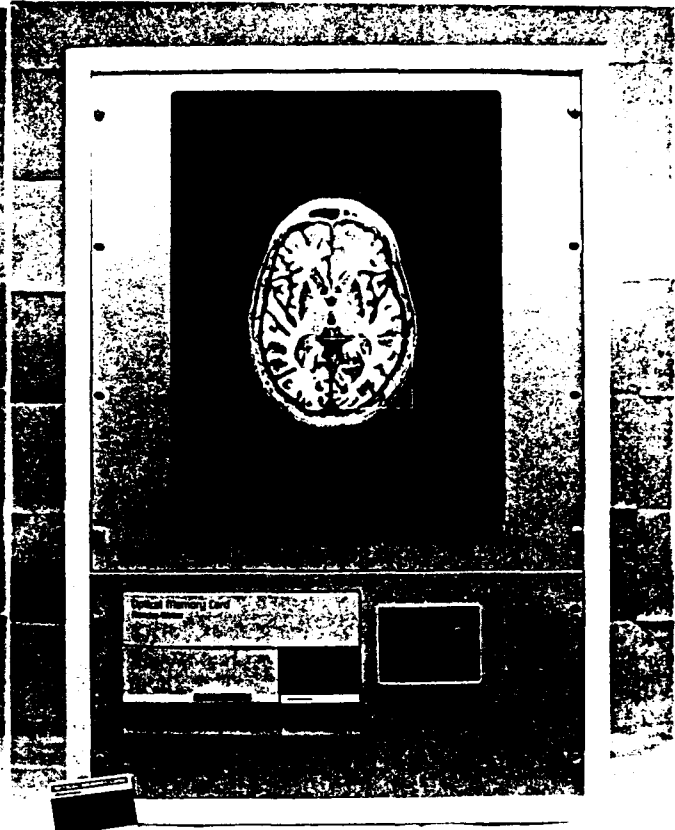

Figure 21. Brain Image with Overlay

## B. Development System

There are approximately half a dozen companies involved in the manufacture of optical card reader/writers. Two companies, Nippon Conlux and Olympus, have demonstrated products suitable for this application. Machines from both companies were used in the development process.

When this project was first proposed in the fall of 1987 several companies were marketing high resolution (1024 x 1280 x 8 display) video boards for AT machines. However, most advertised hardware did not really exist. After evaluating several of the products, the GSC 1400 model 108 from Omnicomp Graphics Corporation was selected. It has an overlay plane which was one of the requirements and a feature that was not available on most of the other boards. The Omnicomp Corporation sales and technical staff were conscientious and provided us with operation manuals prior to the purchase of the board.

Two AT compatible computers were used in the development of the independent viewer, a Zenith Z-248 and a Jameco JE1008. The Zenith Z-248 AT-compatible computer was selected based on the large number of vacant bus slots, the discount to university users, technical documentation, and CPU speed. The Z-248 came standard with a dual floppy/dual hard drive controller card which took up only one bus slot, leaving six free slots. The computer came with a 20 MB hard drive and a 5.25" high density floppy. A 40 MB hard drive and 360 KB floppy drive were added later. The Zenith ZCM-1490 Flat Tension Mask (FTM) monitor was also used. This is a 14", 640 x 480 VGA-compatible RGB, with the patented flat screen which dramatically reduces eye strain.

The Zenith Z-445 memory expansion board takes up one of the Zenith slots and brings the base memory up to 640 KB. An Omnicomp Graphics Corp. video board which drives the high resolution portrait monitor uses the other Zenith slot. An Intel Aboveboard uses an AT slot and provides 2 MB of extended memory for use as a virtual disk. An AT&T DSP32-based floating-point accelerator board manufactured by Communication Automation & Control occupies a PC slot. A serial port and parallel printer port board occupy the last PC slot. The serial port is used as a Hewlett-Packard plotter driver. The parallel port drives an Epson dot matrix printer. The remaining AT slot is filled with either the Microtek scanner (present source of digitized images) control board or the control board for either the Olympus or Nippon Conlux optical card reader/writer machine. A serial port and a parallel port are standard on the Zenith CPU board. A Logitech mouse connects to the serial port, and a 4-button keypad interfaces to the parallel port for simulating the independent viewer control.

To update the operating system for the independent viewer requires reprogramming its ROMdisk board in the Zenith computer. This process involves removing the

accelerator board since the ROMdisk requires a PC slot, and disabling the two hard disk drives. The hard drives have to be disabled because the ROMdisk appears as drive C: as would a hard drive. The disabling of the drives and rebooting from drive A: is accomplished using Zenith's multi-function Monitor program.

The original motherboard in the Jameco computer was a JE1003, this board was later upgraded by the vendor to a JE1007. The JE1007 board was used in the independent viewer assembly, and a more advanced motherboard, the JE3005 was installed in the development computer.

The JE3005 is populated with 1 MB of 100 nsec RAM. A Jameco JE1082 memory expansion and multifunction board provides 3 MB of extended memory for a virtual disk. There are separate controller boards for the 30 MB hard drive and the 5.25" high density floppy drive. The Jameco JE1050 monochrome/graphics/printer adapter board drives a 12" monochrome monitor and an Epson dot matrix printer. An Omnicomp video board drives a VMI monitor and the Communication Automation & Control accelerator board is also used in this computer.

A Western Digital EtherCard Plus board allows the transfer of image files and development programs by Ethernet between the Jameco computer and a Macintosh II computer.

### C. Base Computer

The independent viewer model is housed in a Hammond 19" rack mount cabinet. Optima brand rack panels were cut to provide the appropriate openings for equipment, power switch, circuit breaker, and power cord. The chassis of the VMI monitor rests on and is clamped to right angle aluminum supports. The monitor is also secured to the front panel by an aluminum hanger bracket. A black plastic bezel supplied by VMI snaps into the front panel to frame the monitor.

A custom fabricated aluminum chassis rests on rubber feet on the floor of the cabinet and is secured to the sides of the cabinet. The Jameco JE1007 AT-compatible motherboard is mounted to this chassis with nylon screws and spacers. An aluminum bracket is fastened to the chassis to provide a support for the plug-in boards. The optical card reader is also bolted to the chassis.

The Jameco JE1007 AT-compatible motherboard is fully populated with 1024 KB of 120 nsec memory chips. The CPU speed is 8 MHz, although it is switch selectable for 6/8/10/12 MHz operation, a faster operating speed would require faster memory chips. There are a total of 8 vacant plug-in bus slots, 6 AT slots and 2 PC slots. The operating system is PC-DOS version 3.10. One feature of the motherboard that is required for use in the independent viewer is the ability to operate without a keyboard. Part of the normal system boot-up procedure is to scan the keyboard and halt the boot procedure if there is a problem with the keyboard. With this motherboard the setup procedure allows the keyboard test to be bypassed. Most computers used in industrial control have this feature but motherboards used in desktop computers often don't.

To provide extended memory for a virtual disk and a parallel port for the 4-button keypad interface, the Jameco JE1082 memory expansion and multifunction board is used. The JE1082 is fully populated with 3 MB of 120 nsec RAM. The virtual disk is comprised of this 3 MB of memory plus 512 KB of memory from the motherboard for a total of 3.5 MB. The JE1082 occupies one AT slot and has a piggy back board.

The Omnicomp high resolution video board and the optical card reader driver board each occupy one AT slot. The Communication Automation & Control accelerator board and the Industrial Computer ROMdisk board each require one PC slot.

A 200 W Jameco power supply, which supplies power for the motherboard and plug-in board bus, is mounted above the yoke of the monitor. The power switch is accessible through the rear panel. The supply also has a 115 VAC switched feedthru which switches the power ON-OFF to the monitor and optical card reader. The 115 VAC power line is protected with a double pole, 15 amp, circuit breaker, which is accessible through the rear panel.

#### D. Floating-Point Accelerator Board

The floating-point accelerator board manufactured by Communication Automation & Control (CA&C) is shown in Figure 22. This board is based on the AT&T DSP32 processor and delivers 12 MFLOPS, a significant level of performance over PC coprocessors such as the 8087 (66 KFLOPS at 8 MHz) and the 80287 (74 KFLOPS at 10 MHz) [26; 27].

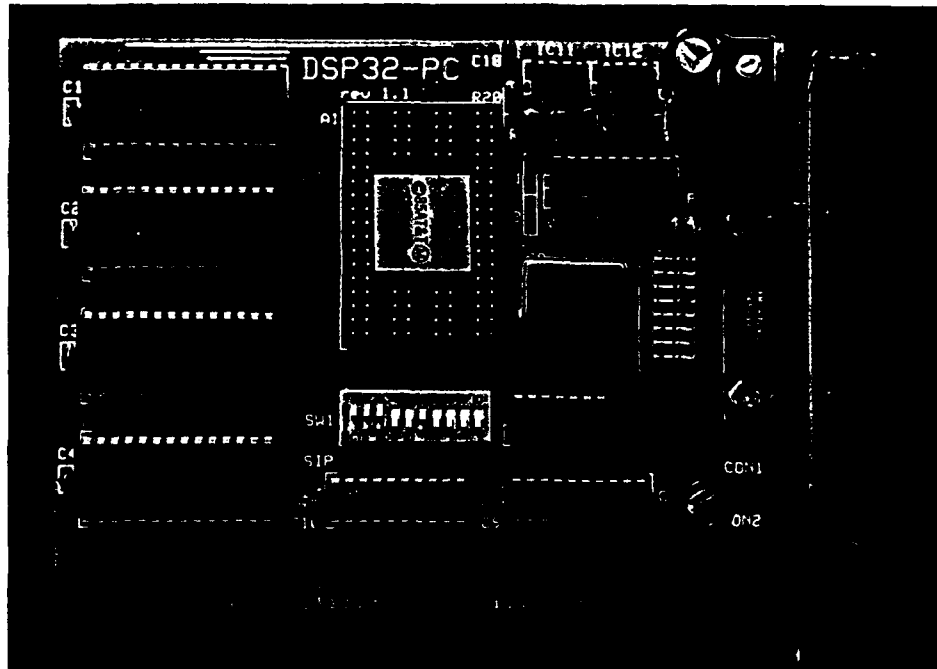

Figure 22. CA&C DSP32-based Accelerator Board

The board is linked to the host by means of an 8-bit parallel port (see Figure 23). To improve the efficiency with which the host and the DSP32 access the on-board memory, the DSP32-PC-160 uses an I/O-mapped interface. In a PC environment, an I/O mapped interface provides two significant advantages over a memory-mapped interface, which was used in earlier accelerator boards to simplify address decoding. First of all, the use of an I/O-mapped interface relieves overcrowding of the PC address space. In a memory-mapped architecture, a portion of the PC's address space would have to be reserved for the accelerator board [26]. Secondly, there is a cost savings, since a memory-mapped interface requires relatively expensive dual-ported static RAM [28].

The DSP32 uses NMOS technology and has an operating frequency of 25 MHz. It incorporates a 32-bit floating-point multiplier and a 40-bit floating-point adder. All DSP32 instructions execute in a single-cycle instruction and include post-normalization for each floating-point operation. An instruction may have two floating-point operations: a floating-point multiply and a floating-point addition yielding 2 floating-point operations per instruction cycle. The DSP32 supports up to four memory accesses per instruction cycle (instruction fetch, 2 operand fetches, and a memory write), which allows for very efficient algorithm coding. The floating-point format is also easier to use than fixed point; operations such as scaling, normalization, and monitoring for



overflow/underflow are performed automatically [29].

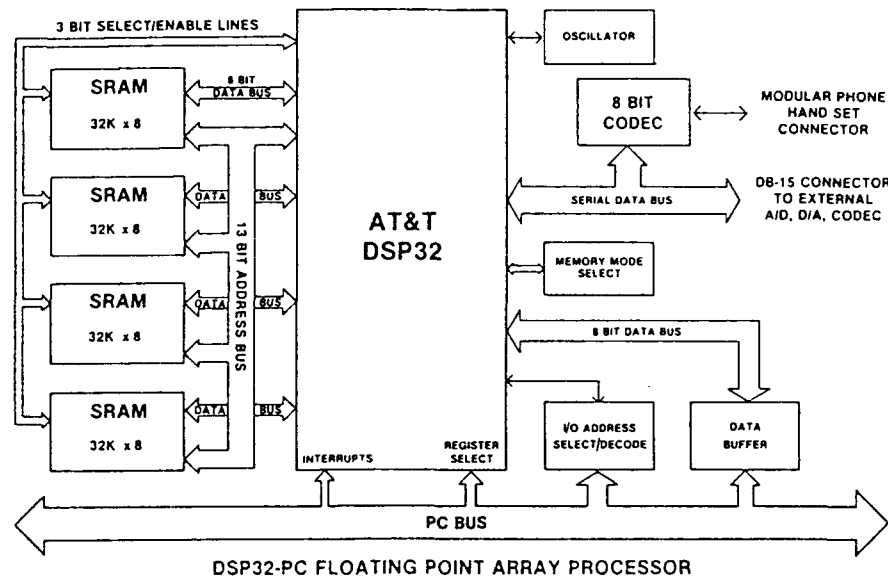

Figure 23. Block Diagram of DSP32-PC-160

The AT compatible and DSP32-PC-160 accelerator board combination has an advantage over a single processor microcomputer with equivalent MIPS and FLOPS of the DSP32. Unlike general-purpose micros, which store instructions and data in separate segments of memory, the DSP32 employs a modified Von Neuman architecture. The DSP32 uses two memory banks, either of which can have instructions and data. To achieve maximum throughput, memory accesses must alternate between the two banks. As one memory bank is accessed, the other memory bank is addressed. This form of pipelining can reduce the effective memory access time by one-half [30; 31].

### 1. Accelerator Board Specifications

This particular processor board was chosen in part because of the availability of the AT&T optimizing C compiler for the DSP32. The optimizing portion of the C compiler performs generic optimizations aimed at taking advantage of the DSP32 instruction set and resources. In addition, the optimizer can analyze program data flow to satisfy data dependencies introduced by some pipeline latencies. Pipeline optimization reorders instructions where possible or uses the NOP (no operation) instruction to flush the pipeline. Although C is a high level language, it offers low

level capabilities that are not found in other languages such as FORTRAN and PASCAL. In particular, the ability to address locations by pointers was used extensively. The C compiler also allowed the development and implementation of the FBTC without writing assembler code [32].

Though the performance of the floating point processor sets the peak performance of the system, it is the overhead associated with invoking the floating point processor and passing it instructions and data that limits throughput. In this application, data passing is not a contributing factor to throughput delay; the bidirectional data transfer between the parallel I/O data bus and the DSP32 processor allows for the uploading or downloading of data while the DSP32 is still calculating. Therefore, the AT uploads data for the next calculation and downloads expanded data for display while the DSP32 is calculating the current expansion.

To help minimize host floating-point processor instruction passing overhead, the DSP32-PC-160 provides a simple and efficient host interface. The application program was written using the Microsoft C version 5.1 compiler. The DSP32 executable code is generated via the AT&T C compiler. This DSP32 code is uploaded to the DSP32-PC-160 by the application program. The application program then calls a C language subroutine that was written by CA&C. This routine starts the processor running in a loop until instructed to begin calculating. To perform a calculation with the DSP32, the host uploads the data on which the calculations are to be performed. The host then sets a flag by writing to a memory address of the DSP32-PC-160, which starts a "while loop". When the DSP32 has finished executing the calculation it resets the flag. When the host computer detects the completion flag it downloads the results of the DSP32 calculations.

## 2. Computing Speed Advantage

What increase of computing power is obtained by applying the DSP32 accelerator to this particular application? To compare the AT-DSP32 with other computer configurations a standard test file was chosen for expansion. The 1024 x 1024 file was constructed from 4 x 4 blocks of the following format:

$$\begin{pmatrix} 121 & 114 & 56 & 47 \\ 37 & 200 & 247 & 255 \\ 16 & 0 & 12 & 169 \\ 43 & 5 & 7 & 251 \end{pmatrix}$$

This file, when compressed represents a worst case scenario for the expansion program. In a given block, if the range of the gray values is less than 16, then the block is not filtered. This is done because the human eye can not distinguish differences of gray scale values in a localized area when the range is less than 16 levels, and where there are 256 gray levels possible.

When the compressed file was expanded using the AT-DSP32 combination, the elapsed time was 17.36 seconds. When the program was run on the 8 MHz AT without the accelerator board, the time was 1543.74 seconds. The program execution time was 58.06 seconds on a 20 megahertz 80386 machine with 80287 coprocessor. Clearly, the AT-DSP32 combination provides superior computational capabilities over the other two microcomputer configurations.

The bus in most AT compatibles operates at 8 MHz, however, some compatibles offer switch selectable bus speeds. If large blocks of data are transferred between the host and the DSP32, then a faster bus would be beneficial. For this particular application, the computer's bus speed is not critical. An image file is relatively large, but the data transfers occur in small blocks while the DSP32 is calculating.

The next consideration is the time required to expand a typical x-ray image. In most images, the neighboring pixels are highly correlated and there are a number of large areas of uniform pixel values. In these areas, the filtering process is not executed and the expansion time for a typical x-ray image takes approximately 6 seconds. This length of time appears to be acceptable to consulting radiologists.

## E. Software

### 1. Development Environment

The Zenith operating system is Zenith MS-DOS 3.3+. The Jameco operating system is PC-DOS 3.1. There are two features of MS-DOS 3.3+ that have been found to be particularly useful that weren't available on previous DOS versions. The first is

the utility, COMPACT. Recompiling large programs and executing image processing routines tends to fragment the disk data rapidly. Accessing fragmented data is time consuming and increases the possibility of losing data. COMPACT arranges the file's clusters sequentially on the disk and sorts directories in alphabetical order by file type and moves them to the front of the disk. The second feature of MS-DOS 3.3+ allows the 40 MB hard drive to be treated as a single drive rather than partitioning it, as previously required with drives larger than 30 MB.

The independent viewer application program is written in Microsoft C 5.1. Both the Microsoft C editor and a Turbo C editor were used for writing the program. All programs were compiled under Microsoft C. Omnicomp supplied library routines for use with Microsoft C, Lattice C, Microsoft Fortran, and Microsoft Assembly.

Several other programs were also used in the development effort. A utility program, PC Tools, allows the viewing of the hex data of image files. This is very important for checking the results of an image processing algorithm. It also was used extensively for analyzing different image file formats (e.g. TIFF, PICT, Dest Uncompressed) and removing the headers from these files. Tops 2.1, a networking software package, was used to communicate with the Macintosh II and transfer images via Ethernet. Picture Publisher is an image editing program bundled with the Microtek scanner which allows scanning images with 256 gray levels. Microsoft Windows 2.03 must be loaded first since Picture Publisher is a Microsoft Windows based application program.

## 2. Control Program

The independent viewer control program is comprised of two files: a source code (.c) file and a header (.h) file. The source file contains approximately 1353 lines of code and the header file contains 123 lines of code. The main code segment consists of an "event" loop which handles all actions. An interrupt handler for the keypad determines the button pushed by the user and sets a global variable. The event loop then checks the global and proceeds to call a subroutine to handle the action.

Ideally the independent viewer control program should maintain a reasonable user response time. Due to inadequate driver software for the optical card reader/writers this is not yet possible. A high-level "system" call is used from within the control pro-

gram to cause the driver to read a file off the data card. Once the driver begins reading a file, it reads the entire file and cannot be interrupted. Since it currently takes 90 seconds to read a compressed image file, the driver monopolizes the machine for that length of time. The end effect of this is that the system will not respond readily to user actions. A temporary solution was to break up each image file into 8 segments. The segments can then be read in sequentially and reassembled in RAM. Any pending actions are handled between segments. This results in a much improved, but still inadequate, user response time of approximately 17 seconds. Overhead associated with reassembling the segments results in a total read time of 136 seconds. A new driver, CARD-TOS from Optical Card of America, should allow low level reads and writes to be performed directly on data card files. Properly implemented low level calls are fully interruptible. With CARD-TOS, image files should not need to be segmented and the system response to user actions should be immediate.

The independent viewer control program is loaded on the ROMdisk from the Zenith 360 KB floppy drive using a utility program supplied with the ROMdisk. This particular ROMdisk has 360 KB of programmable memory available, approximately 231 KB are actually used. There are a total of 7 files that comprise the control program. Two files (COMMAND.COM and VDISK.SYS) are from PC-DOS 3.10. COMMAND.COM is a utility that provides the interface for communication with the DOS shell. VDISK.SYS is the device driver for the virtual disk. LCSP1P.SYS is the device driver for the Olympus optical card reader/writer parallel interface. CONFIG.SYS is read when DOS initializes and is where the presence of the device drivers is detected. The AUTOEXEC.BAT file is automatically read, it contains an instruction to set the accelerator board I/O address to 0x380 and to begin execution of the application program. The application program is an 82 KB file that was compiled under Microsoft C. The last file is a routine called from the application program which was compiled under the AT&T DSP32 C compiler, and is loaded onto the accelerator board to perform the image expansion calculations.

### 3. Data Expansion

Reconstructing an image from the optical card data involves a repetitive process of expanding and filtering 4 x 4 pixel blocks [20]. The filter is used to reduce the "blocky" artifact that is inherent in many block truncation coding (BTC) schemes [18]. If expansion were the only process involved, then the AT compatible would be

sufficient for the task. But, because of the filtering process used with the BTC, which involves convolving all 1,048,576 bytes of the original image data with a 3 x 3 kernel, the AT would require an unreasonable amount of computing time. To supply the necessary computing power for filtering the expanded image, the CA&C accelerator board (see Figure 22) was incorporated in the independent viewer.

When the accelerator board has expanded and filtered 4 lines (4096 pixels) of data, the data is sent to the video board for immediate display. Because of the high speed of the process, the image is painted across the screen in under 6 seconds.

#### F. Expansion Bus Conflicts

Whenever a number of peripheral device driver boards and other plug-in boards are interfaced to the AT expansion bus (Industry Standard Architecture, ISA) there is a possibility of bus conflicts because two or more boards may communicate through the same I/O address ports or transfer data on the same DMA channel. There is also the possibility that the motherboard or the plug-in board is not fully compatible with the IBM-AT standard. All of these conditions were dealt with in the development process.

The Olympus optical card reader/writer and the ROMdisk are both set to use DMA channel 1. To remedy the problem, the reader/writer was set to operate on DMA channel 3 by changing dip switch settings on the interface board and altering the software driver source code with PC Tools.

The CA&C accelerator board defaults to I/O address 0x300, as do both the Nippon Conlux and Olympus optical card reader/writers. CA&C made provisions to readily set the address to 0x380 by changing dip switch settings and using the SET command in the AUTOEXEC.BAT file.

It was found that the Jameco JE1007 mother board memory map was not fully compatible with the IBM-AT standard. In particular, video RAM was mapped to an area that is normally reserved for expansion ROM. This is also the same memory address of the ROMdisk board. To solve this memory address conflict, a new PAL was blown for the ROMdisk board which allows it to address a memory area that is available on the JE1007 motherboard, as well as the Zenith computer, which does follow the IBM-AT standard.

## IX. Potential For Improvement

Presently, the only drawback to the independent viewer is the excessive length of time required to display an image. The most positive improvement will be the increase in the reading speed of the optical card machines. The optical card reader/writer devices have improved during the study from a data capacity of 900 KB to 2.9 MB and a reading rate of 2 KB/sec to about 10 KB/sec. The manufacturers have said that reading rates will double during the next year and may not increase much beyond that unless market pressures force some fundamental changes. The 20 KB/sec would mean that about 45 sec would elapse from the time of insertion of a card in the reader to completion of the display of the first image.

The slow reading rate is caused by practical limitations of the reciprocating motion of the laser reading head relative to the card. While rectilinear data storage eases the problem of locating data on the card, the servo control problem is formidable. There are at least two ways of overcoming this: by circular scanning or by using a small disc or resonant motion by mounting the scanning head on a leaf spring frame. The leaf spring frame would have to oscillate at 5 Hz and 3 cm or more as the card translates beneath it.

Circular scanning of a very small card, essentially a 5.0 cm diameter center section of music compact disc, has a number of advantages. The mechanism and the technology are transferable from compact discs to small data discs and the configuration already has reading data rates above 110 KB/sec. An open card, one not enclosed in a protective cassette, could be handled in the same way as proposed for the "credit cards". Larger cards, i.e. 8.75 cm optical discs in cassettes, are an "overkill" for this application as they have too much data capacity, are far more expensive and are larger than the 5.0 cm open discs when considered for this particular application. However, the company proposing the 5.0 cm discs has not yet decided whether to market them.

The optical cards have been standardized through the DELA (Drexler European Licensees Association) Standard and other standards (ISO, ANSI) are being developed. Several manufacturers are now producing cards and machines and there may be no economic incentive to develop alternatives, i.e., discs. The market seen for the cards is primarily in banking and patient text records and the manufacturers have to be convinced of the value of the medical imaging market. Once convinced, development of faster scanning methods should proceed. The sheer size of the medical film market indicates the potential for

marketing the cards. However, the present sellers in that market have strong vested interests in excluding any non-film image storage means.

Small speed increases in the independent viewer could also be realized by optimizing the expansion algorithm and by writing the accelerator board routines in assembly language rather than C. A more elegant compression/expansion algorithm could be incorporated which would reduce the size of an image file, thus reducing the reading/writing time of an optical card.

Future independent viewer units would be considerably more compact and inexpensive than the feasibility model. The total equipment cost of the independent viewer feasibility model is approximately \$10,000. By incorporating an optical reader only, rather than a reader/writer, and purchasing the components in quantity, the cost could be significantly reduced. Instead of the optical card reader having its own power supply, it could run off the computer power supply. Instead of using a motherboard, a passive backplane with a plug-in CPU board that has 4 MB of on-board memory capability and a parallel port would obviate the memory expansion/multifunction board.

The issue of requirements for image display will only be resolved by clinical evaluation and acceptance of any system. While it is easy to show that display factors less than 1024 x 1024 x 8 bits cannot show sufficient detail required for chest radiography, arguments for higher resolution must be based on certain compromises. Display systems of 5000 x 6000 x 10 bits have been built with storage depth of 12 bits (one claim is 16 bits). It must be pointed out that the conference speaker describing that system and the consequences of not using displays of that level represented a film company. Other high resolution displays have been built as 2048 x 2048 x 12 bits. The latter system requires about six times the data space as the 1024 x 1024 x 8 bit system and costs more than ten times as much. Some clinical studies have shown that for most studies, there is no loss of diagnostic quality with the 1024 display. For those few situations where higher resolution/image is required, sub-images could be displayed at 1024 lines as quadrants of the original image. Again, clinical studies of the utility of 1024 line and higher resolution displays must be made to resolve this issue before considering the need for improvement in this area.

The proposal for this program included subcontracting of the development and fabrication of scanners and cassettes containing stimulable phosphors. Commercial computed radiography, CR, systems scan at high resolution and high bit depth, display the image at



1024 lines and copy the final image on single emulsion film for the archive. Clinical evaluations of CR systems verify their performance as equivalent to conventional film-screen methods but with greater convenience and lower material cost/image. However, capital costs of those systems are rather high and they have been proposed only for use with DIN/PACS, i.e., larger hospitals. To meet the requirements for high resolution copying to single emulsion film, the present scanners must be constructed as very precise and high cost machines.

Because the proposed filmless radiography system was limited to a 1024 display, the high resolution/high precision requirements of the scanner could be relaxed. It was felt that the performance limitations would not affect the diagnostic utility for field or clinical use as there would be no requirement for archiving on single emulsion film. The reduced performance requirements would make possible the design of a scanner of reduced size and cost and of greater durability and ruggedness. A more subtle issue was whether a deliberate reduction of performance would expose the user to the threat of malpractice. The commercial approach was to over-design so that no accusation of reduced performance could be made. The effect of over-design on a PC-based system would be to extend the memory and computing requirements to the point where that system would be infeasible.

If the malpractice risk to the practitioner were not present, then the original concept of a small scanner would remain valid. One way of resolving the issue of clinical utility would be to conduct a comparison of film-screen systems, high resolution CR and the 1024 method suggested here. Because there is sufficient justification for 1024 line systems for industrial radiography, it would be reasonable to develop a scanner for that purpose and then evaluate for medical imaging.

## X. Conclusions

The central idea of using small computers and PC's with high resolution monitors has been shown to be feasible for use in medical imaging. Optical discs as a clinical image archive and optical cards as a patient image transfer medium parallels the present clinical film file and film copies. With the use of standard bus structures (SCSI) and Ethernet, existing image editing and reporting methods have been shown to be inexpensive and reasonable alternatives to workstations and elegant and interactive communication means. While this approach will not replace larger DIN/PACS systems, such systems may not be appropriate for small clinics or field hospitals at the present state of the technology. The concept of lower cost, reduced complexity, and standard components translates into better maintainability, availability, and reliability. Commercial companies are expressing interest for ultrasound and radiotherapy imaging and treatment planning. As less expensive and less elaborate stimuable phosphor cassettes and scanners become available they can be connected to this system to become a filmless x-ray/medical imaging department of a small clinic or field hospital. All of the functions of scheduling, reporting, imaging, archiving and communicating have been accommodated. While the system of the original proposal has not been assembled and completed, the results of the project have found many commercial applications in the forms of stimuable phosphor scanners, improved workstations, and inexpensive image compression. Publication of the results has stimulated others in research on the use of optical data cards and discs for the storage of medical images. At least one company has indicated that a commercial system embodying the principles developed in this research will be built and offered commercially.

## List of References

- [1] Siedband, M.P., et al. "Filmless Radiographic System for Army Field Hospitals." *Proceedings of SPIE 1093*. Newport Beach, CA. May 1989.
- [2] Willis, AR., et al. "Standard for Optical Memory Cards and Devices." Drexler European Licensees Association (DELA). British Telecom. London. 1989.
- [3] Shiina, S., and Nishibori, M. "Problems and Solutions in the Clinical Application of Laser Card." *Proceedings of the Twelfth Annual Symposium on Computer Applications in Medical Care*. Washington, D.C. Nov. 1988.
- [4] Siedband, M. P., Heilman, C. A., Grenzow, F. C. "Optical Data Card for Medical Imaging." To be presented at SPIE Medical Imaging IV. Newport Beach, CA. Feb. 1990.
- [5] Apple Programmer's and Developer's Association. "The Macintosh Family Hardware Reference." Draft 2. March 1987.
- [6] Diagnostic Research, Inc. "Macintosh or MS-DOS?" Report synopsis prepared for Apple Computer. 1988.
- [7] American National Standard for Information Systems - Small Computer System Interface (SCSI), ANSI X3.131-1986. American National Standards Institute, Inc. New York, NY, 1986.
- [8] Spencer, Cheryl E. "High-Capacity Hard Disks." *Macworld*, Nov. 1989, pp. 160-169.
- [9] SuperMac Technology. *DataFrame User's Manual*. 1987.
- [10] Rizzo, John. "Letting in the Light." *MacUser*, Nov. 1989, pp. 132-155.
- [11] Freese, Robert P. "Optical Disks Become Erasable." *IEEE Spectrum*, Feb. 1988.
- [12] Stallings, William. *Integrated Services Digital Networks (ISDN)*. 2nd ed. Tutorial. Washington D.C.: IEEE Computer Society Press, 1988.
- [13] Apple Computer, Inc. *Human Interface Guidelines: The Apple DeskTop Interface*. Reading, MA: Addison-Wesley Publishing Company, Inc., 1987.
- [14] Knaster, S. *Macintosh™ Programming Secrets*. Reading, MA: Addison-Wesley Publishing Company, Inc., 1988.
- [15] Simpson, H. *Programming the Macintosh™ User Interface*. New York, NY: McGraw-Hill Book Company, 1986.
- [16] Tag Image File Format Rev. 4.0. Aldus Corporation and Microsoft Corporation. 31 April 1987.
- [17] Rosenfeld, A., and Kak, A. C. *Digital Picture Processing*. 2nd ed. Vol. 1. Orlando: Academic Press, 1982. pp. 154-155.

## List of References

- [18] Delp, E. J., and Mitchell, O. R. "Image Compression Using Block Truncation Coding." *IEEE Transactions on Communications*. Vol. COM-27. No. 9 (Sept. 1977): pp. 1335-1342.
- [19] Eversole, W. L., et al. "Investigation of VLSI Technologies for Image Processing." *Proceedings: Image Understanding Workshop*. Pittsburgh, PA. 14 -15 Nov. 1978.
- [20] Siedband, M. P., Zhang, H., and Gray, J. R. "Block Truncation Image Compression with Bit-map Compensation." *Computers in Physics*. Vol. 3, No. 6 (Nov/Dec 1989): pp. 52-56.
- [21] Burt, P. J., and Adelson, E. H. "The Laplacian Pyramid as a Compact Image Code." *IEEE Transactions on Communications*. Vol. COM-31, No. 4 (April 1983): pp. 532-540.
- [22] Siedband, M.P., et al. "Filtered Block Truncation Image Compression." Presented at RSNA. Chicago, IL. Nov. 1989.
- [23] Huang, H. K. *Elements of Digital Radiology - A Professional Handbook and Guide*. Englewood Cliffs: Prentice-Hall, 1987. p. 214.
- [24] Siedband, M.P. and Grenzow, F.C. "Independent Viewer for Optical Data Cards." *Proceedings of the Annual International Conference of the IEEE Engineering in Medicine and Biology Society*. Seattle, WA. Part 2/6. Volume 11:1989.
- [25] Siedband, M.P., et al. "Optical Data Cards for Filmless Radiography." Presented at SPIE Optical Engineering Midwest. Northbrook, IL. 3 Nov. 1989.
- [26] Manuel, T. "Array Boards Give IBM PCs Near-Minisuper Speed." *Electronics*, 31 Mar. 1988. p. 65.
- [27] Marrin, K. "Plug-in array accelerators transform PCs into low-cost DSP, floating-point workstations." *Personal Engineering & Instrumentation News*. June 1988. p. 41.
- [28] Maliniak, D. "Plug-In Array Processor Gives PCs 25 Low-Cost MFLOPS." *Electronic Design*, 17 Mar. 1988. p. 131.
- [29] AT&T. "WE® DSP32 Digital Signal Processor Information Manual." June, 1988. Chapters 1 and 2.
- [30] Bridges, James E. personal communication. Dec. 1989. Communication Automation & Control. 1642 Union Blvd. Allentown, PA 18103.
- [31] AT&T. "WE® DSP32 Digital Signal Processor Data Sheet." Mar. 1988. pp. 1-5.
- [32] AT&T. "WE® DSP32 and DSP32C C Language Compiler User Manual." Aug. 1988. Chapter 1.